

Prøve 	1: 9.1 ↑ 2: 10.1 ↖ 3: 9.5 → 4: 8.9 ← 5: 9.3 ↑ 6: 9.5 ↙ 8: 9.1 ↗ 9: 10.7x ↘ 10: 10.7x ↘	Prøve 	11: 10.1 ↖ 12: 9.7 ← 13: 9.4 ← 14: 8.7 ← 15: 9.2 ↖
Serie 83.0		Serie 45.0	
Total 0.0		Total 0.0	

60 Skud 	1: 10.4 ↘ 2: 10.1 → 3: 9.2 → 4: 9.9 → 5: 8.9 → 6: 8.1 ↑ 7: 9.0 ← 8: 10.7x ↗ 9: 10.1 ↗ 10: 8.9 ↗	60 Skud 	11: 8.4 ↑ 12: 8.8 ↙ 13: 9.1 ↙ 14: 8.8 ↑ 15: 8.2 ← 16: 10.1 → 17: 9.5 ↗ 18: 10.3 ↗ 19: 9.4 ↓ 20: 9.9 →
Serie 91.0		Serie 88.0	
Total 91.0		Total 179.0	

60 Skud 	21: 9.4 ↖ 22: 9.1 ↑ 23: 8.8 ← 24: 10.3 ← 25: 9.6 → 26: 10.4 ↓ 27: 7.9 ← 28: 10.3 ↓ 29: 9.9 ← 30: 9.9 ←	60 Skud 	31: 9.0 ↓ 32: 9.9 ↓ 33: 9.1 ↙ 34: 9.9 ↗ 35: 8.9 ← 36: 10.0 ← 37: 10.0 ← 38: 10.0 ↑ 39: 9.7 → 40: 6.7 ←
Serie 90.0		Serie 89.0	
Total 269.0		Total 358.0	

Prøve 	Prøve 	1: 9.9 ← 2: 9.4 → 3: 7.6 ↓ 4: 9.8 → 5: 9.5 ↑ 6: 10.5x↘ 7: 9.7 ← 8: 10.7x↘ 9: 9.5 ↑ 10: 8.7 ↓ <hr/> Serie 89.0 Total 0.0	11: 9.6 ↘ 12: 9.0 ← 13: 10.5x→ 14: 9.2 ↑ 15: 10.0 ↖ <hr/> Serie 47.0 Total 0.0
-----------	-----------	--	--

40 Skud 	40 Skud 	1: 9.0 ↑ 2: 10.0 ↗ 3: 9.6 ↑ 4: 10.0 ↑ 5: 9.4 ↓ 6: 8.0 ↓ 7: 10.1 ↖ 8: 10.3 → 9: 9.9 ← 10: 10.1 ↑ <hr/> Serie 94.0 Total 94.0	11: 8.8 ↓ 12: 10.6x↘ 13: 9.0 ↘ 14: 9.7 ↓ 15: 10.0 ↖ 16: 9.4 ↓ 17: 10.1 ← 18: 10.2 → 19: 9.5 → 20: 9.6 ↘ <hr/> Serie 93.0 Total 187.0
-------------	-------------	--	---

40 Skud 	40 Skud 	21: 9.6 → 22: 8.0 ↓ 23: 9.7 ↑ 24: 9.8 ↑ 25: 10.0 ↖ 26: 10.8x↘ 27: 9.6 ↘ 28: 9.7 ↗ 29: 9.6 → 30: 9.0 ↓ <hr/> Serie 91.0 Total 278.0	31: 9.5 ↓ 32: 9.8 ↓ 33: 7.0 ↑ 34: 10.5x↘ 35: 8.9 ↑ 36: 6.4 ↓ 37: 8.8 ↓ 38: 9.5 ↑ 39: 9.9 ↘ 40: 9.7 ↗ <hr/> Serie 84.0 Total 362.0
-------------	-------------	---	--

	10 meter luftstævne 2015	Aalborg Skyttekreds
--	--------------------------	---------------------

<p>Prøve <span style="float:right; font-size:24px;">8</span></p>	<p>1: 10.2 ↗ 2: 9.0 ↗ 3: 10.0 ↗ 4: 8.7 ↗ 5: 9.7 ↓ 6: 10.1 ← 7: 9.7 ← 8: 10.6x ↗ 9: 10.3 ↑ 10: 8.8 ↓</p> <p>Serie 93.0 Total 0.0</p>	<p>60 Skud <span style="float:right; font-size:24px;">7</span></p>		<p>1: 9.3 ↖ 2: 10.4x ↓ 3: 10.1 ↗ 4: 8.3 ↗ 5: 7.6 ↖ 6: 9.3 ← 7: 10.0 ↓ 8: 7.7 ↓ 9: 8.8 ↓ 10: 10.2 ←</p> <p>Serie 88.0 Total 88.0</p>
--	---	--	--	---

<p>60 Skud <span style="float:right; font-size:24px;">4</span></p>	<p>11: 10.5x ↗ 12: 4.6 ↑ 13: 9.7 ↓ 14: 9.1 ↗ 15: 8.4 ← 16: 10.6x ↑ 17: 10.9x → 18: 8.4 → 19: 9.0 ↗ 20: 9.5 ↗</p> <p>Serie 86.0 Total 174.0</p>	<p>60 Skud <span style="float:right; font-size:24px;">8</span></p>		<p>21: 9.6 ← 22: 9.1 ↓ 23: 10.1 ↑ 24: 10.7x ← 25: 10.0 ← 26: 9.3 ↑ 27: 9.7 ↓ 28: 9.0 ← 29: 9.1 ↑ 30: 9.7 ←</p> <p>Serie 93.0 Total 267.0</p>
--	--	--	--	--

<p>60 Skud <span style="float:right; font-size:24px;">6</span></p>	<p>31: 6.4 ↑ 32: 9.3 ← 33: 10.0 ↑ 34: 9.2 ↓ 35: 10.0 ↓ 36: 10.4x ↗ 37: 10.7x ↑ 38: 8.9 ↓ 39: 9.5 → 40: 8.9 ←</p> <p>Serie 89.0 Total 356.0</p>	<p>60 Skud <span style="float:right; font-size:24px;">7</span></p>		<p>41: 9.2 → 42: 10.6x ↗ 43: 7.7 ↑ 44: 9.2 ↖ 45: 10.3 → 46: 9.5 ↓ 47: 10.1 ↓ 48: 9.6 ↗ 49: 10.0 → 50: 9.9 ←</p> <p>Serie 92.0 Total 448.0</p>
--	--	--	--	---

<p>60 Skud <span style="float:right; font-size:24px;">8</span></p>	<p>51: 9.0 ↗ 52: 9.5 ↖ 53: 8.5 ↓ 54: 8.5 ↗ 55: 9.4 ↓ 56: 10.0 ↓ 57: 9.1 → 58: 10.7x ↓ 59: 8.6 ↑ 60: 9.8 ↓</p> <p>Serie 89.0 Total 537.0</p>			
--	---	--	--	--

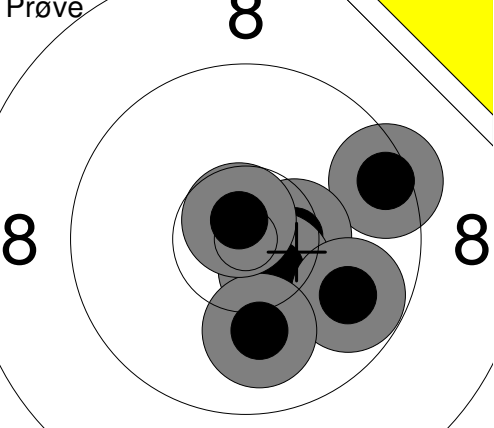
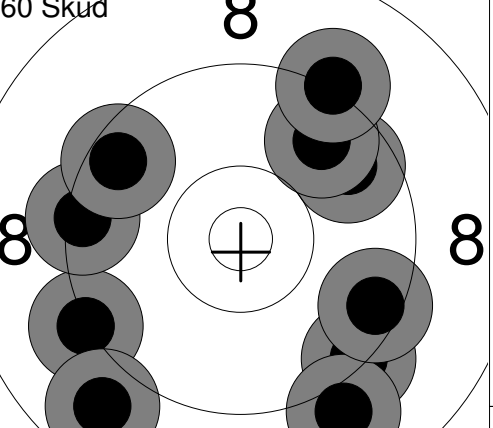
Prøve 	1: 9.5 → 2: 10.5x → 3: 10.5x ↘ 4: 9.8 ↘ 5: 10.0 ↘ 6: 10.7x ↗	60 Skud 	1: 9.3 ↘ 2: 9.2 ← 3: 9.0 ↘ 4: 9.5 ↘ 5: 8.8 ↘ 6: 9.4 ← 7: 9.5 ↗ 8: 9.7 ↗ 9: 9.7 ↗ 10: 9.2 ↗
	Serie 58.0		Serie 89.0
	Total 0.0		Total 89.0

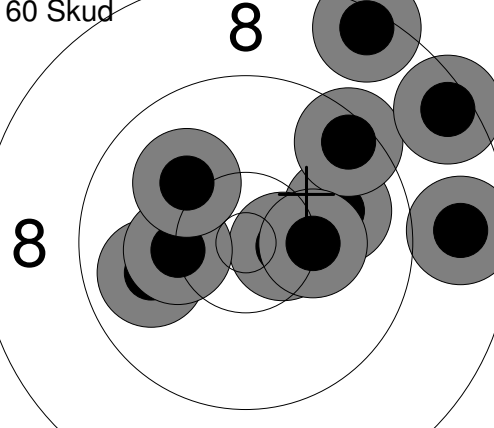
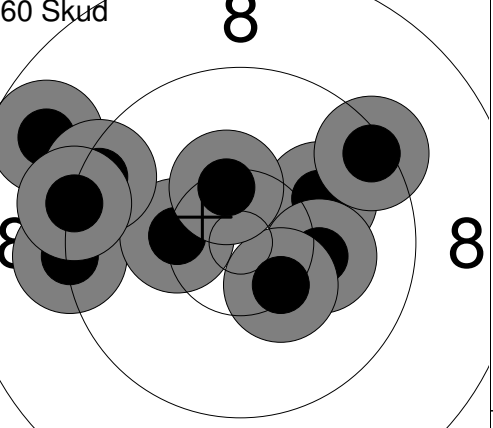
60 Skud 	11: 9.9 ← 12: 10.0 → 13: 9.5 ↗ 14: 10.6x → 15: 8.4 ↗ 16: 8.7 → 17: 10.3 ← 18: 10.3 → 19: 8.5 ↗ 20: 10.1 ↗	60 Skud 	21: 10.1 ↗ 22: 10.2 → 23: 9.3 ← 24: 10.3 ← 25: 8.8 ↗ 26: 10.4x ↘ 27: 9.4 ↗ 28: 10.4x ↗ 29: 9.4 ↗ 30: 9.3 ←
	Serie 92.0		Serie 94.0
	Total 181.0		Total 275.0

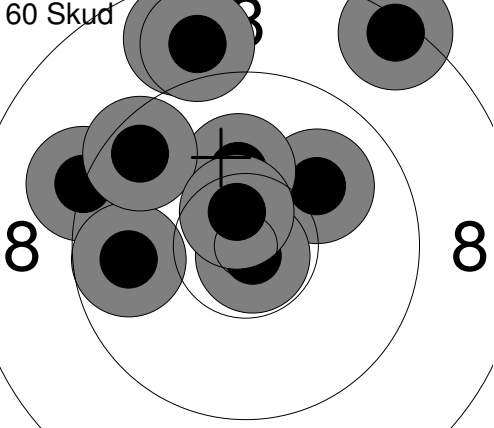
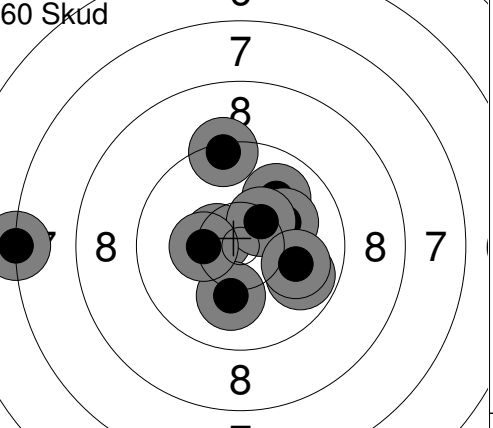
60 Skud 	31: 10.0 ↗ 32: 9.2 ← 33: 10.2 ↗ 34: 8.8 ↗ 35: 8.9 ↗ 36: 9.8 ← 37: 9.6 ↗ 38: 10.8x ↘ 39: 8.4 ↗ 40: 10.6x ↗	60 Skud 	41: 10.5x ← 42: 9.4 ↗ 43: 10.0 ↗ 44: 10.1 ↗ 45: 9.8 ↘ 46: 7.2 ← 47: 10.4x ↗ 48: 10.0 → 49: 10.1 ↘ 50: 10.3 ←
	Serie 91.0		Serie 95.0
	Total 366.0		Total 461.0

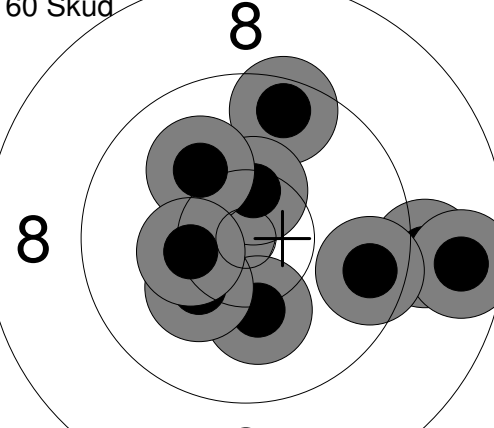
60 Skud 	51: 9.6 ↗ 52: 10.7x ← 53: 9.1 → 54: 8.7 → 55: 10.2 ↘ 56: 9.6 → 57: 10.4x ↗ 58: 10.2 ↘ 59: 10.1 ↗ 60: 10.4x ←		
	Serie 95.0		
	Total 556.0		

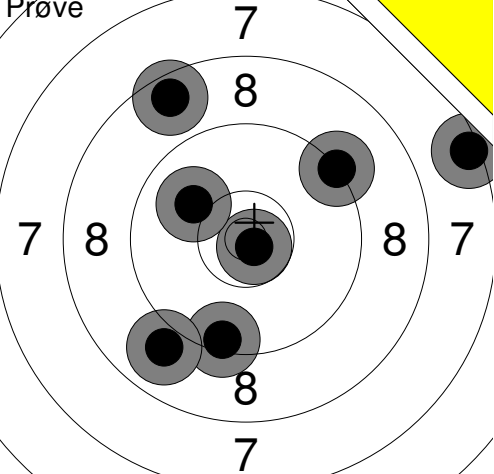
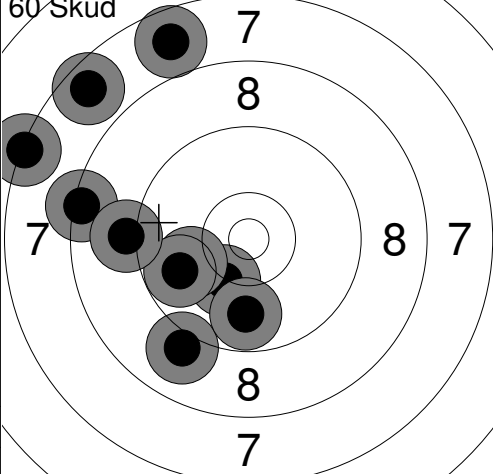
<p>Prøve</p> 	<p>1: 8.6 ↗ 2: 10.8x ↓ 3: 10.0 ↗ 4: 9.2 ↗ 5: 7.4 → 6: 9.4 ↓ 7: 8.9 ↓</p>	<p>60 Skud</p> 	<p>1: 10.2 ↓ 2: 10.0 ← 3: 7.6 ↗ 4: 7.3 ← 5: 9.0 ↓ 6: 9.8 ← 7: 8.4 ← 8: 9.1 ← 9: 9.8 ↓ 10: 7.7 ↗</p>
Serie	61.0	Serie	85.0
Total	0.0	Total	85.0

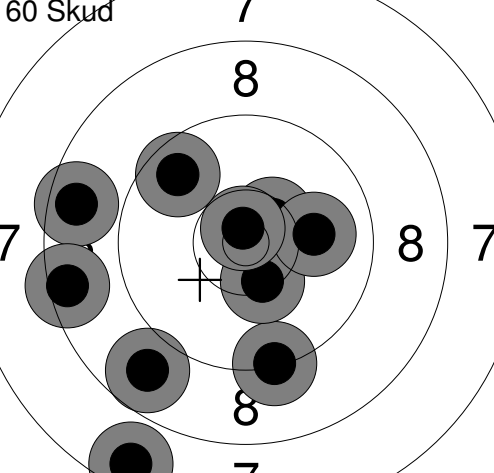
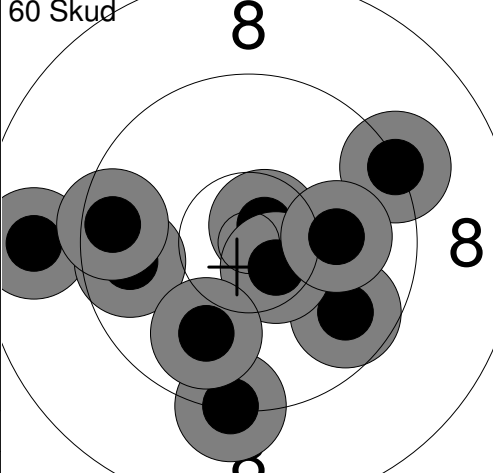
<p>60 Skud</p> 	<p>11: 10.5x ↗ 12: 9.3 ↓ 13: 10.4x ↓ 14: 8.6 ← 15: 8.5 ← 16: 10.0 → 17: 10.8x ↑ 18: 7.6 ↓ 19: 8.8 ↓ 20: 9.7 ↗</p>	<p>60 Skud</p> 	<p>21: 8.8 ← 22: 10.7x ↗ 23: 9.3 ↗ 24: 9.7 ↓ 25: 9.3 ↓ 26: 9.7 ← 27: 10.6x ↓ 28: 9.6 ← 29: 10.1 → 30: 9.9 ↓</p>
Serie	89.0	Serie	92.0
Total	174.0	Total	266.0

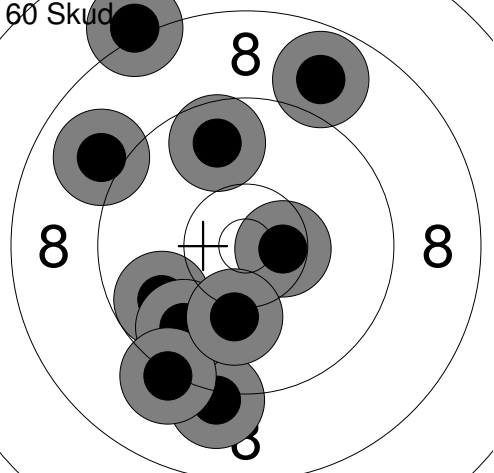
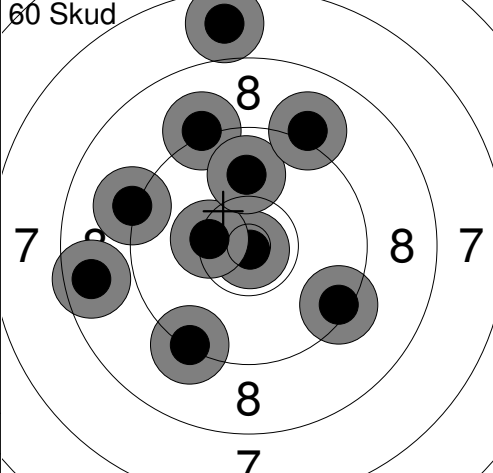
<p>60 Skud</p> 	<p>31: 8.1 ↗ 32: 9.1 ↓ 33: 9.8 ← 34: 9.8 ↓ 35: 9.0 ↗ 36: 10.5x → 37: 9.2 ↓ 38: 10.1 ↓ 39: 8.8 ↗ 40: 9.7 ↗</p>	<p>60 Skud</p> 	<p>41: 10.9x ↓ 42: 10.4x ← 43: 7.7 ↑ 44: 9.2 ↗ 45: 8.6 ← 46: 9.9 ↑ 47: 9.4 ↓ 48: 9.1 ↗ 49: 9.3 ↓ 50: 9.2 ←</p>
Serie	90.0	Serie	89.0
Total	356.0	Total	445.0

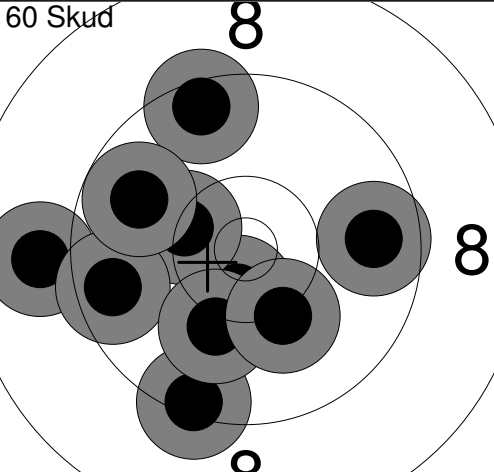
<p>60 Skud</p> 	<p>51: 9.5 ↑ 52: 8.9 ← 53: 10.5x ↓ 54: 10.3 ← 55: 9.4 ↓ 56: 9.6 ← 57: 9.8 ↗ 58: 9.7 → 59: 10.1 ↓ 60: 10.2 ↓</p>		
Serie	93.0		
Total	538.0		

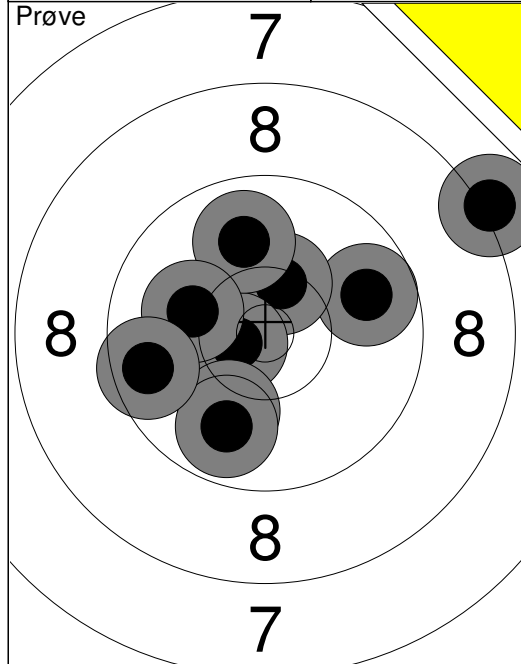

1:	10.4x ↗
2:	9.8 →
3:	10.4x ↗
4:	10.6x ↘
5:	10.0 ↓
6:	9.9 ↑
7:	9.9 ↓
8:	8.1 →
9:	10.1 ↖
10:	9.6 ←
Serie	94.0
Total	0.0

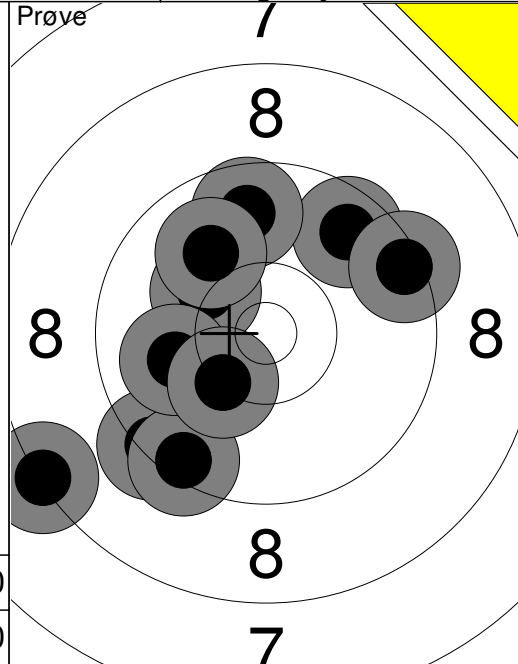

11:	10.2 ↖
12:	9.6 ↗
13:	9.4 →
14:	8.3 ↖
15:	9.7 ↑
16:	9.3 ↖
17:	9.4 ↓
18:	10.0 ↖
19:	10.0 ↖
20:	10.3 ↘
Serie	93.0
Total	0.0

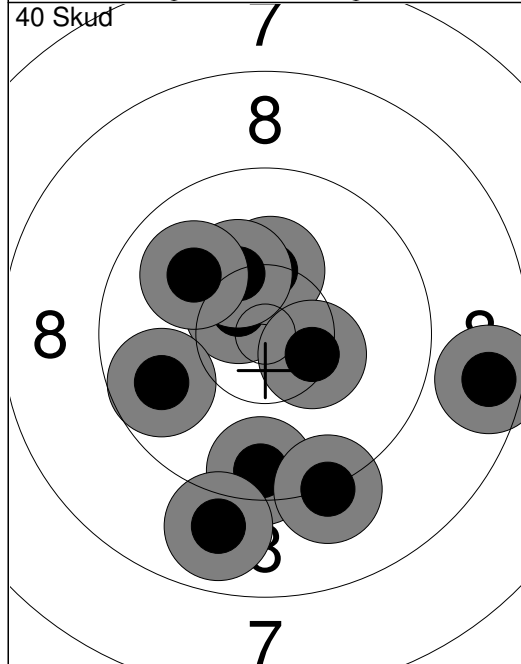

1:	9.5 ↓
2:	9.2 ↓
3:	10.6x ↘
4:	8.9 ↓
5:	10.3 ↑
6:	8.6 →
7:	10.4x ↗
8:	10.3 ↗
9:	10.0 ↖
10:	9.8 ←
Serie	93.0
Total	93.0

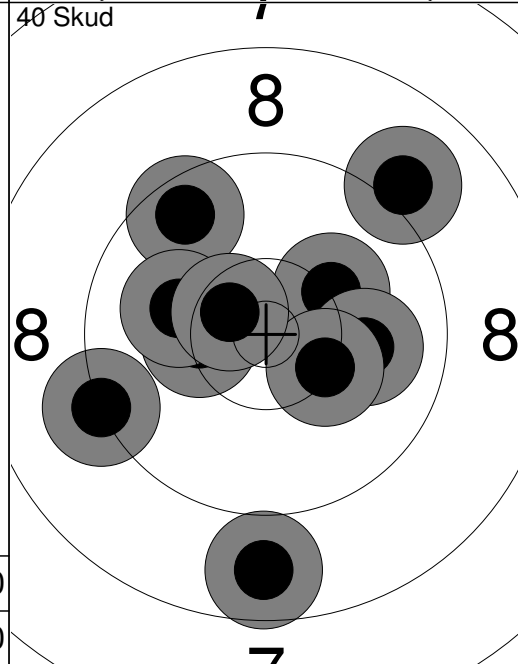

11:	10.3 ←
12:	9.6 ↖
13:	10.2 ↗
14:	9.0 ↗
15:	8.7 ↓
16:	10.1 ↖
17:	10.0 →
18:	9.2 ↖
19:	10.3 ↗
20:	10.5x ↘
Serie	95.0
Total	188.0

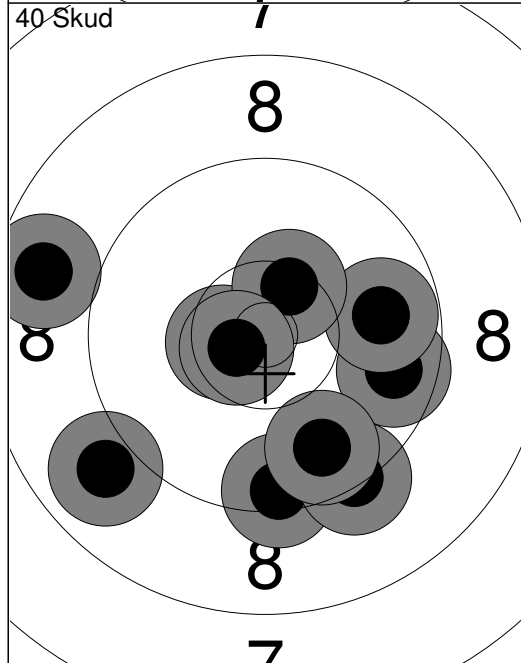

21:	9.4 ↓
22:	9.7 →
23:	9.8 →
24:	10.5x ↖
25:	8.7 ↖
26:	9.3 ↓
27:	10.4x ↗
28:	9.7 ↓
29:	8.9 ↖
30:	10.6x ↖
Serie	91.0
Total	279.0

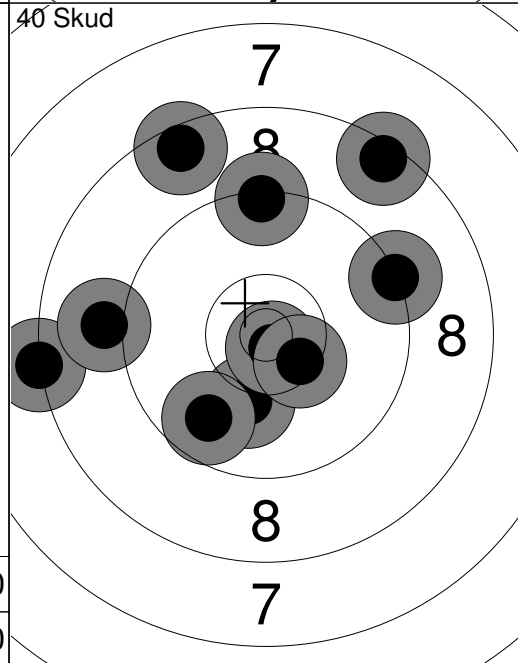

31:	8.2 ←
32:	10.1 ↓
33:	10.8x ↘
34:	10.4x ↘
35:	9.0 ←
36:	9.7 ↖
37:	9.3 ↑
38:	8.5 ↖
39:	9.3 →
40:	8.4 ↗
Serie	90.0
Total	369.0

Prøve 	1: 9.8 → 2: 10.5x↘ 3: 9.4 ← 4: 10.2x→ 5: 9.6 ↗ 6: 9.0 ↓ 7: 9.6 → 8: 9.6 → 9: 9.8 ↓ 10: 9.9 ↓ Serie 97.4 Total 0.0	Prøve 	11: 9.6 ↘ 12: 9.9 ↖ 13: 10.5x↘ 14: 10.5x→ 15: 10.6x↘ 16: 9.1 ← 17: 9.5 → Serie 69.7 Total 0.0
-----------	--	-----------	---

40 Skud 	1: 9.5 → 2: 9.8 ↓ 3: 9.4 ↓ 4: 10.0 ↑ 5: 9.7 ↑ 6: 10.0 ↘ 7: 10.3x↘ 8: 10.5x↘ 9: 10.0 → 10: 9.6 → Serie 98.8 Total 98.8	40 Skud 	11: 10.1 → 12: 9.6 ↓ 13: 9.5 ↓ 14: 9.1 → 15: 9.9 → 16: 10.6x→ 17: 9.8 → 18: 9.6 ↙ 19: 10.3x↑ 20: 9.7 ↓ Serie 98.2 Total 197.0
-------------	--	-------------	--

40 Skud 	21: 10.4x↘ 22: 10.6x↘ 23: 9.7 ↖ 24: 8.7 ↖ 25: 10.7x↘ 26: 9.3 ↓ 27: 8.4 ↖ 28: 9.9 ↗ 29: 9.3 ↗ 30: 10.1 → Serie 97.1 Total 294.1	40 Skud 	31: 9.3 ↖ 32: 9.7 → 33: 9.6 ↘ 34: 9.9 → 35: 10.6x↑ 36: 9.5 → 37: 10.5x↘ 38: 10.9x↘ 39: 10.3x↗ 40: 10.3x↘ Serie 100.6 Total 394.7
-------------	---	-------------	---

	10 meter luftstævne 2015	Aalborg Skyttekreds
--	--------------------------	---------------------

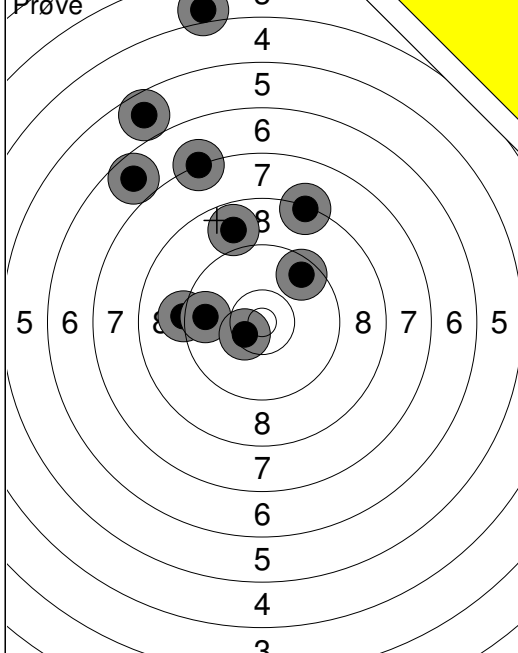

1:	5.7	↖
2:	4.0	↑
3:	6.7	↖
4:	7.2	↑
5:	8.8	↑
6:	9.2	←
7:	9.7	←
8:	8.3	↗
9:	10.5	↙
10:	9.6	↗
Serie		75.0
Total		0.0

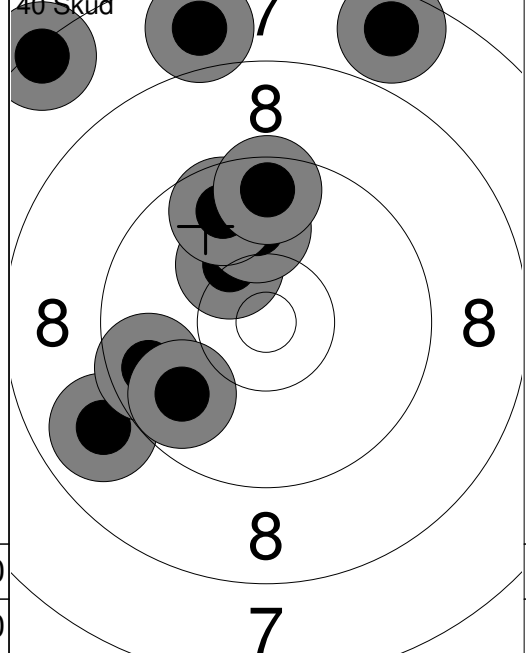

1:	7.6	↗
2:	8.9	↖
3:	10.2	↖
4:	7.8	↑
5:	10.0	↑
6:	9.7	↑
7:	9.6	↖
8:	7.3	↖
9:	9.8	↖
10:	9.6	↑
Serie		85.0
Total		85.0

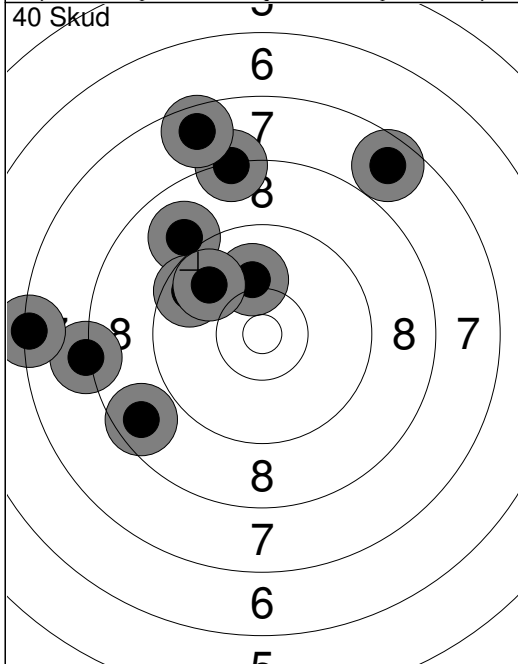

11:	8.2	←
12:	7.3	←
13:	7.7	↗
14:	8.6	↖
15:	8.3	↑
16:	9.0	↖
17:	7.6	↑
18:	10.1	↑
19:	9.6	↖
20:	9.8	↖
Serie		82.0
Total		167.0

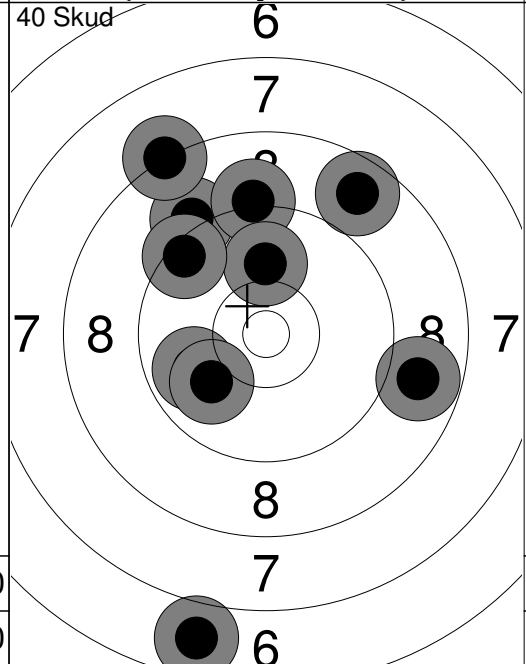

21:	9.1	↖
22:	8.2	↖
23:	9.2	↑
24:	8.7	↗
25:	10.0	↑
26:	9.4	↖
27:	8.8	→
28:	9.9	↖
29:	10.0	↙
30:	6.8	↓
Serie		86.0
Total		253.0

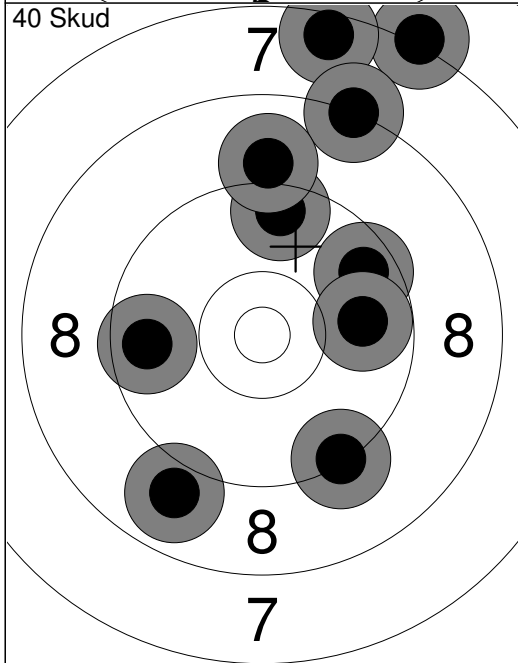

31:	7.2	↗
32:	7.5	↑
33:	8.2	↗
34:	9.6	↗
35:	9.6	←
36:	9.8	→
37:	9.3	↘
38:	9.5	↑
39:	8.9	↙
40:	9.0	↑
Serie		84.0
Total		337.0



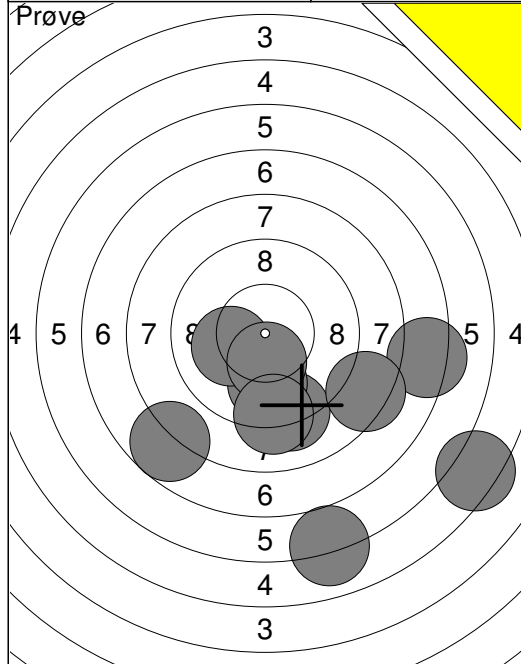

1: 6.0 ↓
2: 7.7 ↙
3: 5.4 ↘
4: 7.3 →
5: 9.1 ↓
6: 9.8 ↓
7: 10.1 ↙
8: 8.4 →
9: 10.3x ↓
10: 9.1 ↓
<b>Serie 83.2</b>
<b>Total 0.0</b>

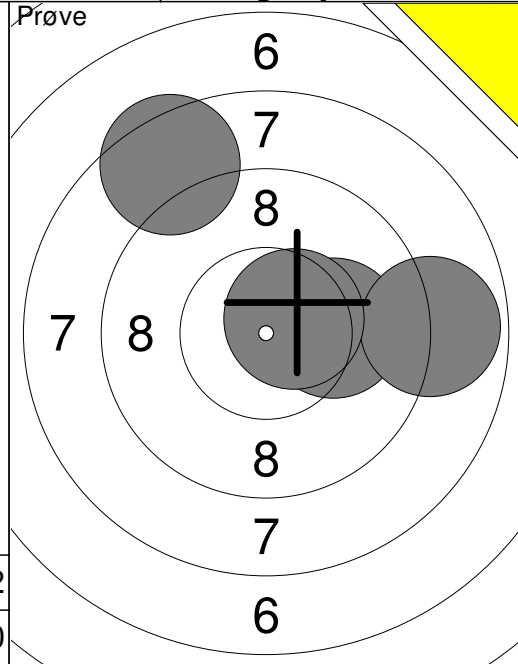

11: 10.1 →
12: 8.9 →
13: 8.5 ↖
14: 10.5x →
<b>Serie 38.0</b>
<b>Total 0.0</b>

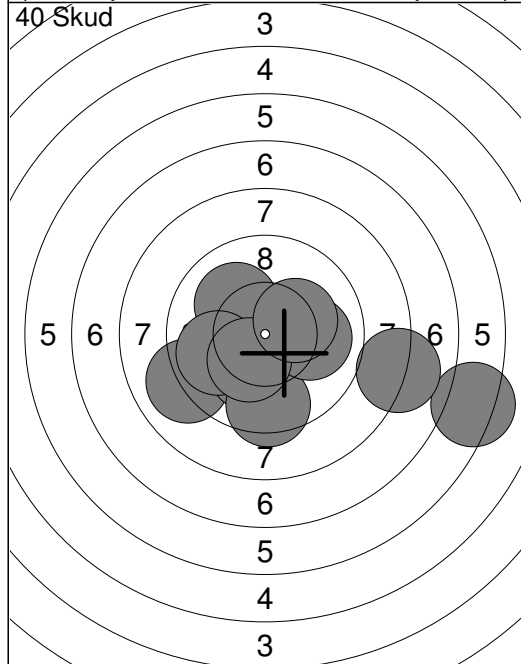

1: 9.0 ↙
2: 6.3 →
3: 10.2x ↙
4: 10.1 ↖
5: 9.5 ↓
6: 8.0 →
7: 10.0 →
8: 9.9 ↙
9: 10.3x ↙
10: 10.2x →
<b>Serie 93.5</b>
<b>Total 93.5</b>

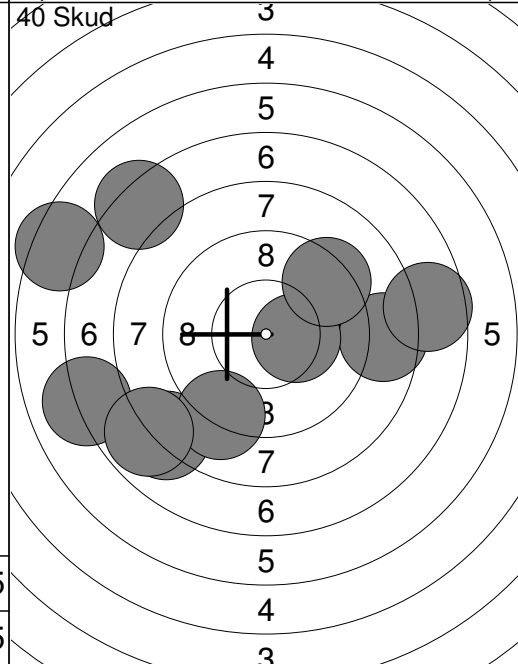

11: 8.1 ↙
12: 7.0 ↙
13: 7.3 ↖
14: 8.6 →
15: 10.3x →
16: 7.6 →
17: 9.1 ↙
18: 6.4 ↙
19: 9.3 ↗
20: 7.8 ↙
<b>Serie 81.5</b>
<b>Total 175.0</b>

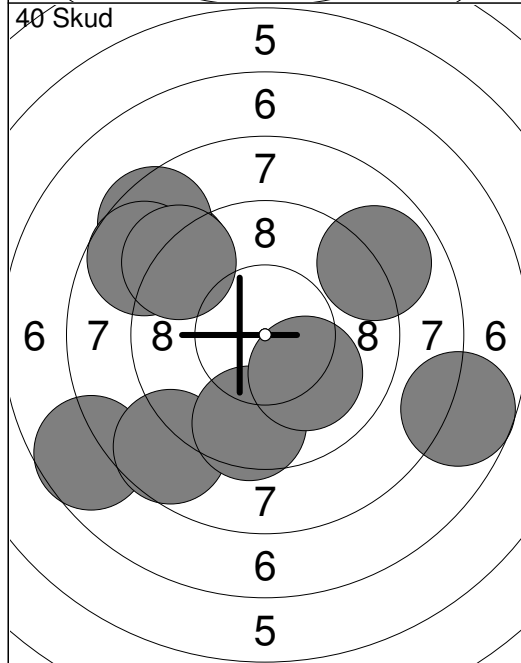

21: 9.1 ↖
22: 7.7 →
23: 7.7 ↙
24: 8.5 ↗
25: 8.9 ↗
26: 8.7 ↙
27: 8.7 ↖
28: 9.2 ↗
29: 9.6 ↓
30: 10.1 ↓
<b>Serie 88.2</b>
<b>Total 263.2</b>

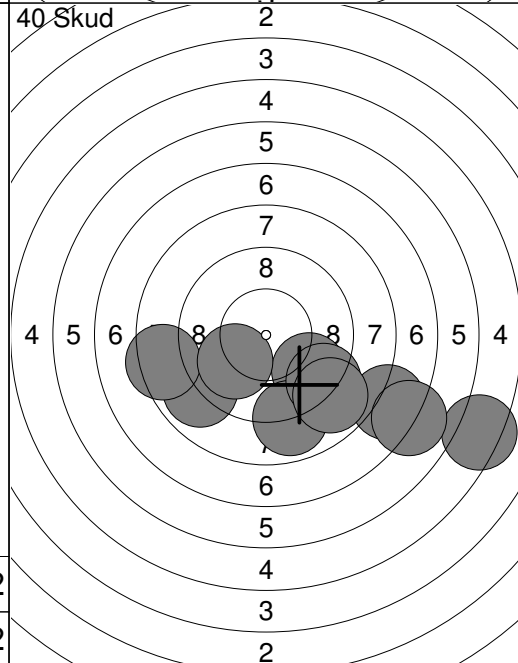

31: 8.9 ↙
32: 7.6 →
33: 9.6 ↘
34: 8.4 ↙
35: 10.0 ↙
36: 5.3 →
37: 7.0 →
38: 8.9 ↓
39: 9.2 ↘
40: 8.8 ↘
<b>Serie 83.7</b>
<b>Total 346.9</b>

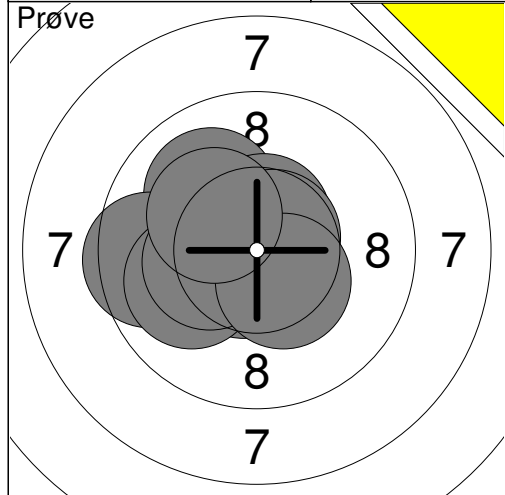

1:	10.0	↖
2:	9.5	←
3:	10.6x	↙
4:	10.7x	←
5:	10.6x	↑
6:	10.0	←
7:	10.3x	←
8:	10.7x	↗
9:	10.4x	↘
10:	10.2x	↗
Serie		103.0
Total		0.0

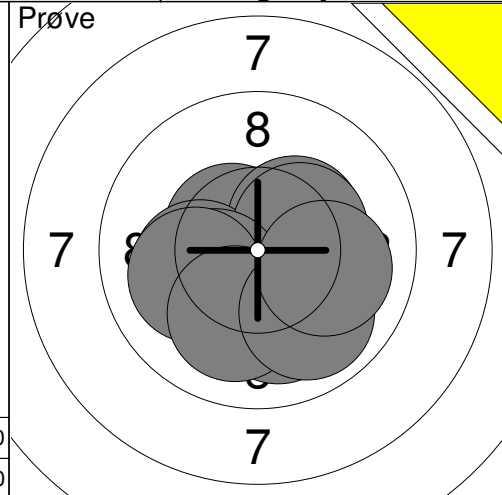

11:	10.5x	↖
12:	10.3x	↗
13:	10.2x	←
14:	10.0	↓
15:	10.3x	↗
16:	10.3x	←
17:	10.1	←
18:	10.1	↓
19:	9.9	↘
20:	10.0	→
Serie		101.7
Total		0.0

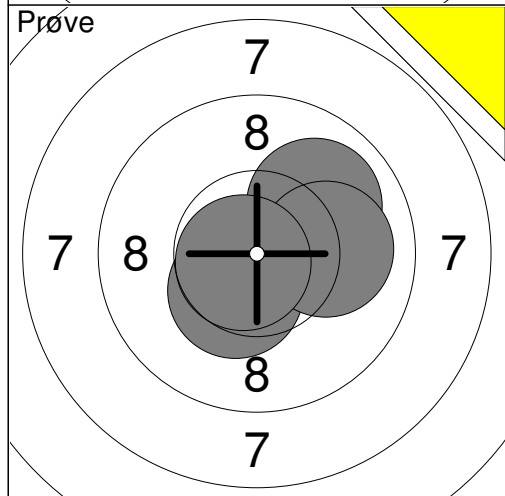

21:	10.4x	↙
22:	10.0	↗
23:	10.0	→
24:	10.7x	↙
Serie		41.1
Total		0.0

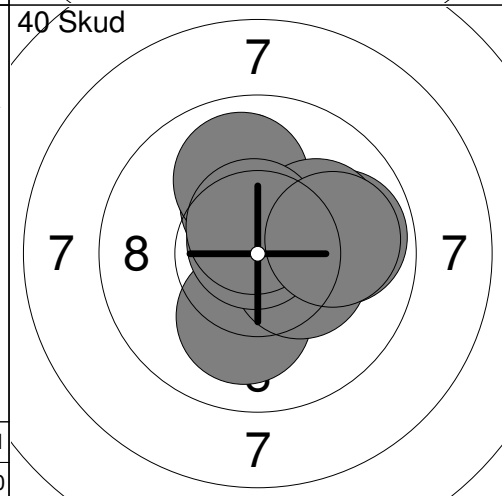

1:	9.9	→
2:	10.3x	↑
3:	10.0	↑
4:	10.7x	↑
5:	10.1	↓
6:	10.1	↗
7:	10.3x	→
8:	10.8x	↑
9:	10.6x	↑
10:	9.9	→
Serie		102.7
Total		102.7

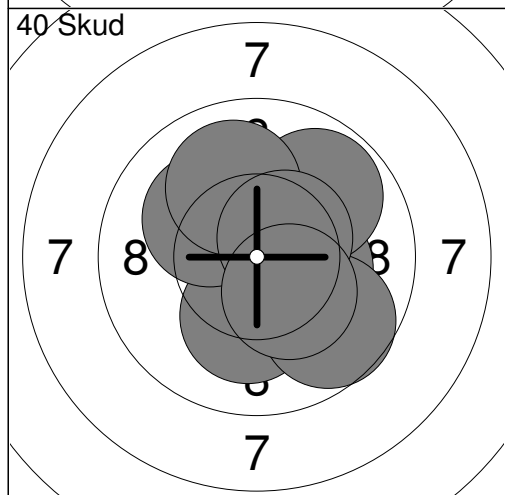

11:	10.3x	→
12:	10.7x	→
13:	10.4x	↓
14:	9.8	↗
15:	10.2x	↓
16:	10.2x	↗
17:	10.0	↗
18:	9.7	↘
19:	10.5x	↗
20:	10.3x	↘
Serie		102.1
Total		204.8

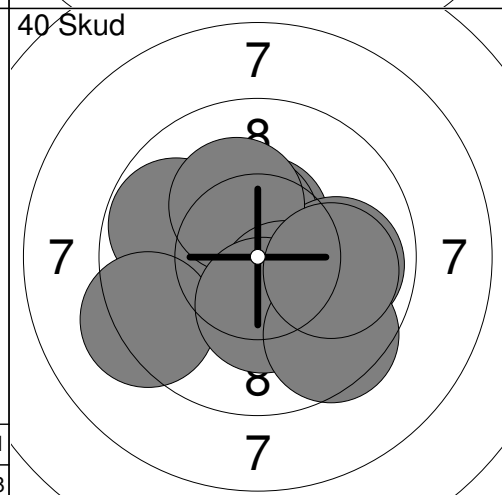

21:	10.5x	↑
22:	10.5x	↑
23:	9.9	→
24:	9.8	←
25:	10.2x	↑
26:	10.4x	↘
27:	9.3	←
28:	10.3x	↓
29:	9.5	↘
30:	10.0	→
Serie		100.4
Total		305.2

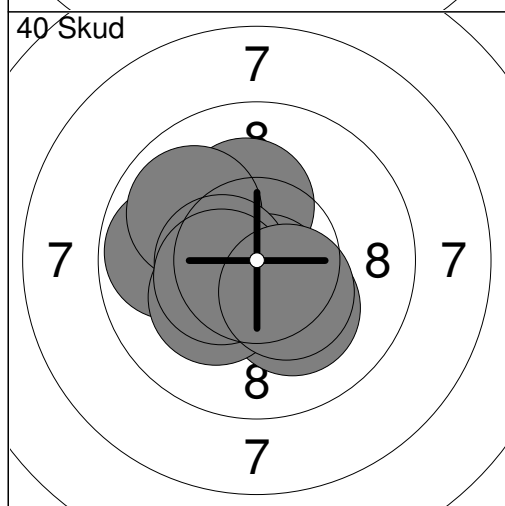

31:	9.8	←
32:	10.2x	↑
33:	10.2x	↘
34:	10.7x	↘
35:	10.6x	↘
36:	9.9	↗
37:	10.2x	↙
38:	10.5x	←
39:	10.4x	←
40:	10.4x	↘
Serie		102.9
Total		408.1

<p>Prøve</p>	<p>1: 9.6 ↓ 2: 9.1 → 3: 9.7 ↓ 4: 10.5x → 5: 9.3 ↑ 6: 9.8 ↗ 7: 10.2x ↗ 8: 9.7 ↗ 9: 10.9x ← 10: 9.8 ↗</p> <p>Serie 98.6 Total 0.0</p>	<p>Prøve</p>	<p>11: 10.1 ↖ 12: 10.8x → 13: 9.9 ↗ 14: 10.4x ↗ 15: 10.5x ↗ 16: 10.8x ← 17: 10.5x ↙ 18: 10.3x ↖ 19: 10.3x ↙ 20: 10.2x ←</p> <p>Serie 103.8 Total 0.0</p>
--------------	---	--------------	--

<p>Prøve</p>	<p>21: 10.2x ← 22: 10.4x ←</p> <p>Serie 20.6 Total 0.0</p>	<p>40 Skud</p>	<p>1: 10.3x ← 2: 10.8x ↙ 3: 9.8 ↗ 4: 10.8x ↑ 5: 9.9 ↑ 6: 9.9 ↑ 7: 10.2x ↑ 8: 10.5x ↓ 9: 10.6x ↙ 10: 10.5x ↗</p> <p>Serie 103.3 Total 103.3</p>
--------------	--	----------------	--

<p>40 Skud</p>	<p>11: 10.7x ↓ 12: 10.4x → 13: 10.1 ↗ 14: 10.2x ← 15: 10.6x ↗ 16: 10.7x ↑ 17: 10.5x ← 18: 10.9x ↗ 19: 10.2x → 20: 10.0 ←</p> <p>Serie 104.3 Total 207.6</p>	<p>40 Skud</p>	<p>21: 10.3x ↑ 22: 10.2x ← 23: 10.7x ↗ 24: 10.2x ↖ 25: 10.4x ↗ 26: 10.8x ↓ 27: 10.3x ↗ 28: 10.2x ↑ 29: 10.5x ↑ 30: 10.6x →</p> <p>Serie 104.2 Total 311.8</p>
----------------	---	----------------	---

<p>40 Skud</p>	<p>31: 10.6x ↗ 32: 10.1 → 33: 10.2x ↓ 34: 10.2x ↓ 35: 10.0 ↓ 36: 10.3x ↓ 37: 10.5x ↖ 38: 10.3x ← 39: 10.6x ↑ 40: 10.7x ↙</p> <p>Serie 103.5 Total 415.3</p>		
----------------	---	--	--

Prøve 	1: 9.9 ← 2: 10.3x→ 3: 9.2 → 4: 10.3x↓ 5: 9.7 ↑ 6: 10.0 → 7: 10.0 ↓ 8: 10.4x← 9: 10.0 → 10: 10.2x← Serie 100.0 Total 0.0	Prøve 	11: 10.1→ 12: 10.3x↗ 13: 10.3x↖ 14: 10.6x→ 15: 10.7x↓ 16: 10.4x↖ 17: 10.5x→ 18: 9.9 → Serie 82.8 Total 0.0
---	--	---	---

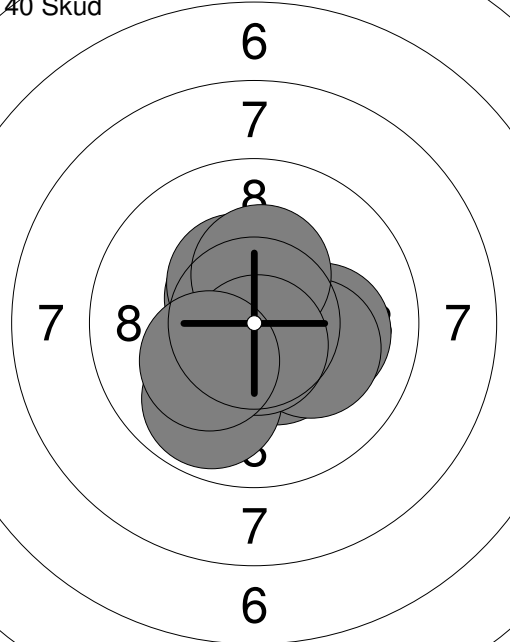
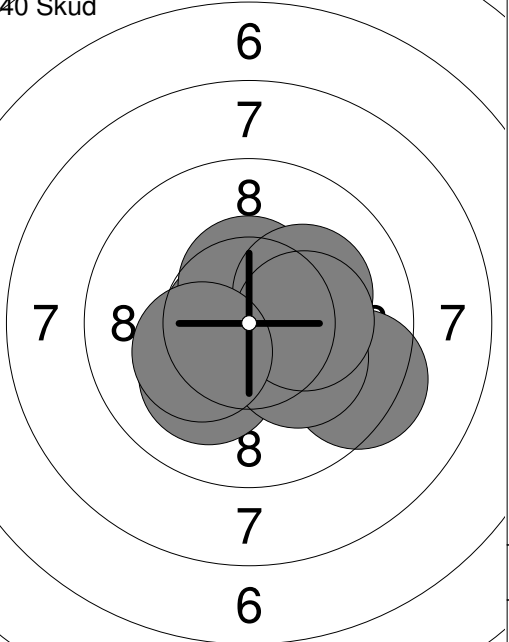
40 Skud 	1: 10.5x↓ 2: 10.7x→ 3: 10.5x↘ 4: 9.8 ↓ 5: 10.1 → 6: 10.4x↘ 7: 10.2x→ 8: 10.3x↖ 9: 10.7x↓ 10: 10.2x↘ Serie 103.4 Total 103.4	40 Skud 	11: 10.8x→ 12: 10.7x← 13: 10.5x↖ 14: 10.1 ↓ 15: 9.4 → 16: 10.4x→ 17: 10.2x↗ 18: 10.2x↘ 19: 10.2x→ 20: 10.2x↘ Serie 102.7 Total 206.1
--	--	--	---

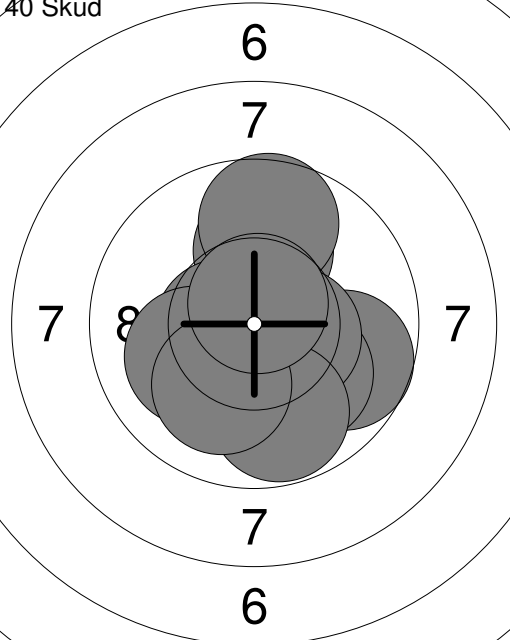
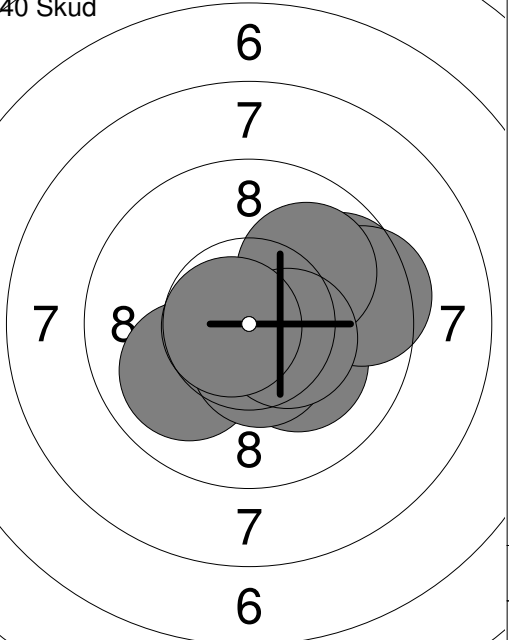
40 Skud 	21: 10.0 ↑ 22: 9.7 → 23: 9.7 ↑ 24: 10.1 ↓ 25: 10.5x→ 26: 10.6x← 27: 10.1 ← 28: 9.8 ↓ 29: 10.1 ↓ 30: 10.7x↖ Serie 101.3 Total 307.4	40 Skud 	31: 10.0 ↙ 32: 10.5x↘ 33: 10.2x↘ 34: 9.7 → 35: 10.5x→ 36: 10.5x↓ 37: 9.5 → 38: 10.0 ↗ 39: 10.4x→ 40: 10.7x← Serie 102.0 Total 409.4
---	---	---	--

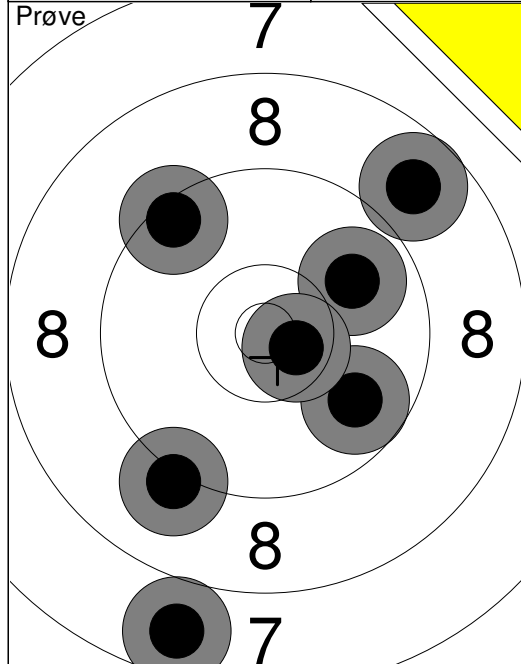

1:	7.7	↓
2:	9.9	↗
3:	8.8	↗
4:	9.4	↖
5:	9.1	↓
6:	9.8	↓
7:	10.6x	→
Serie		61.0
Total		0.0

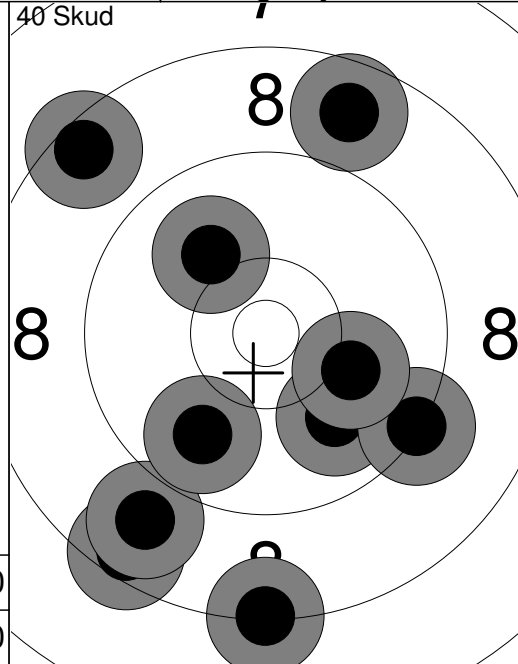

1:	9.9	↓
2:	8.3	↓
3:	8.5	↓
4:	8.8	↓
5:	8.5	↗
6:	9.3	↓
7:	8.7	↗
8:	10.1	→
9:	9.8	↓
10:	10.0	↖
Serie		87.0
Total		87.0

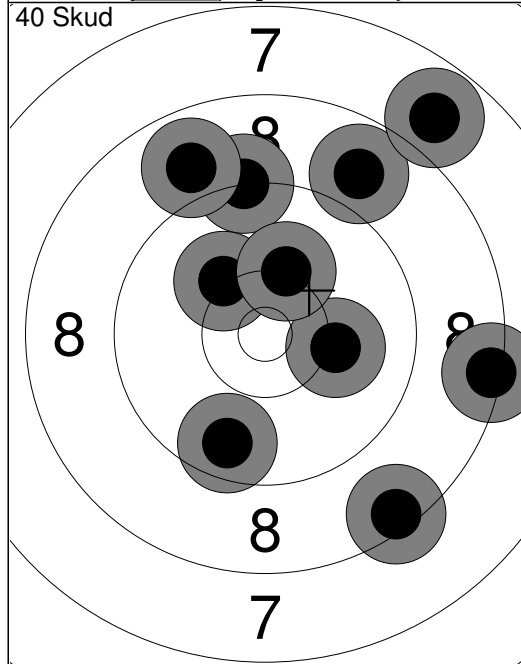

11:	9.2	↗
12:	8.4	→
13:	10.2	↖
14:	10.1	→
15:	8.4	↓
16:	8.8	↗
17:	10.2	↗
18:	7.8	↗
19:	8.9	↖
20:	9.6	↓
Serie		87.0
Total		174.0

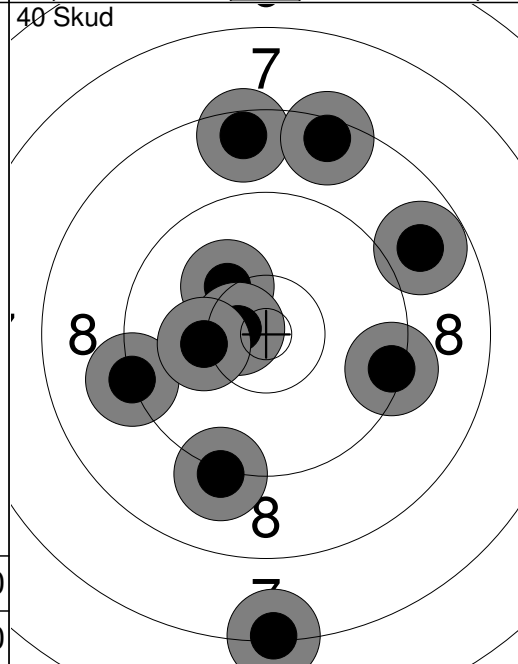

21:	9.4	→
22:	8.5	↗
23:	8.8	↗
24:	9.2	↓
25:	7.3	↓
26:	10.2	↖
27:	10.6x	↖
28:	8.5	↗
29:	9.2	↖
30:	10.2	↖
Serie		88.0
Total		262.0

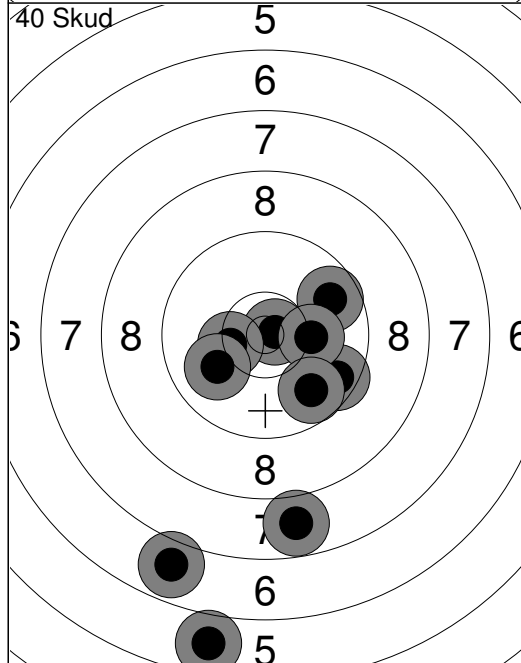

31:	9.6	→
32:	7.8	↓
33:	10.8x	→
34:	6.8	↓
35:	10.3	↖
36:	9.7	↗
37:	10.0	↖
38:	10.2	→
39:	9.8	↓
40:	5.8	↓
Serie		85.0
Total		347.0

<b>Prøve</b> 	<table border="1" style="width:100%; border-collapse: collapse;"> <tr><td>1:</td><td>8.0</td><td>↘</td></tr> <tr><td>2:</td><td>9.9</td><td>↗</td></tr> <tr><td>3:</td><td>9.0</td><td>↑</td></tr> <tr><td>4:</td><td>10.1</td><td>↗</td></tr> <tr><td>5:</td><td>9.6</td><td>↙</td></tr> <tr><td>6:</td><td>10.6x</td><td>↗</td></tr> <tr><td>7:</td><td>7.9</td><td>↗</td></tr> <tr><td>8:</td><td>9.8</td><td>↗</td></tr> <tr><td>9:</td><td>9.8</td><td>→</td></tr> <tr><td>10:</td><td>9.1</td><td>↗</td></tr> <tr><td colspan="2"><b>Serie</b></td><td>89.0</td></tr> <tr><td colspan="2"><b>Total</b></td><td>0.0</td></tr> </table>	1:	8.0	↘	2:	9.9	↗	3:	9.0	↑	4:	10.1	↗	5:	9.6	↙	6:	10.6x	↗	7:	7.9	↗	8:	9.8	↗	9:	9.8	→	10:	9.1	↗	<b>Serie</b>		89.0	<b>Total</b>		0.0	<b>Prøve</b> 	<table border="1" style="width:100%; border-collapse: collapse;"> <tr><td>11:</td><td>9.0</td><td>↗</td></tr> <tr><td>12:</td><td>9.7</td><td>↙</td></tr> <tr><td colspan="2"><b>Serie</b></td><td>18.0</td></tr> <tr><td colspan="2"><b>Total</b></td><td>0.0</td></tr> </table>	11:	9.0	↗	12:	9.7	↙	<b>Serie</b>		18.0	<b>Total</b>		0.0																								
1:	8.0	↘																																																																									
2:	9.9	↗																																																																									
3:	9.0	↑																																																																									
4:	10.1	↗																																																																									
5:	9.6	↙																																																																									
6:	10.6x	↗																																																																									
7:	7.9	↗																																																																									
8:	9.8	↗																																																																									
9:	9.8	→																																																																									
10:	9.1	↗																																																																									
<b>Serie</b>		89.0																																																																									
<b>Total</b>		0.0																																																																									
11:	9.0	↗																																																																									
12:	9.7	↙																																																																									
<b>Serie</b>		18.0																																																																									
<b>Total</b>		0.0																																																																									
<b>60 Skud</b> 	<table border="1" style="width:100%; border-collapse: collapse;"> <tr><td>1:</td><td>9.9</td><td>↘</td></tr> <tr><td>2:</td><td>8.7</td><td>→</td></tr> <tr><td>3:</td><td>8.4</td><td>→</td></tr> <tr><td>4:</td><td>7.8</td><td>→</td></tr> <tr><td>5:</td><td>8.5</td><td>↑</td></tr> <tr><td>6:</td><td>7.8</td><td>↗</td></tr> <tr><td>7:</td><td>8.8</td><td>↙</td></tr> <tr><td>8:</td><td>8.8</td><td>↗</td></tr> <tr><td>9:</td><td>10.6x</td><td>↗</td></tr> <tr><td>10:</td><td>10.4x</td><td>←</td></tr> <tr><td colspan="2"><b>Serie</b></td><td>83.0</td></tr> <tr><td colspan="2"><b>Total</b></td><td>83.0</td></tr> </table>	1:	9.9	↘	2:	8.7	→	3:	8.4	→	4:	7.8	→	5:	8.5	↑	6:	7.8	↗	7:	8.8	↙	8:	8.8	↗	9:	10.6x	↗	10:	10.4x	←	<b>Serie</b>		83.0	<b>Total</b>		83.0	<b>60 Skud</b> 	<table border="1" style="width:100%; border-collapse: collapse;"> <tr><td>11:</td><td>8.9</td><td>↗</td></tr> <tr><td>12:</td><td>9.3</td><td>↖</td></tr> <tr><td>13:</td><td>7.4</td><td>←</td></tr> <tr><td>14:</td><td>9.1</td><td>→</td></tr> <tr><td>15:</td><td>9.2</td><td>↘</td></tr> <tr><td>16:</td><td>7.9</td><td>↗</td></tr> <tr><td>17:</td><td>8.1</td><td>↑</td></tr> <tr><td>18:</td><td>9.2</td><td>↙</td></tr> <tr><td>19:</td><td>9.8</td><td>↗</td></tr> <tr><td>20:</td><td>8.7</td><td>←</td></tr> <tr><td colspan="2"><b>Serie</b></td><td>83.0</td></tr> <tr><td colspan="2"><b>Total</b></td><td>166.0</td></tr> </table>	11:	8.9	↗	12:	9.3	↖	13:	7.4	←	14:	9.1	→	15:	9.2	↘	16:	7.9	↗	17:	8.1	↑	18:	9.2	↙	19:	9.8	↗	20:	8.7	←	<b>Serie</b>		83.0	<b>Total</b>		166.0
1:	9.9	↘																																																																									
2:	8.7	→																																																																									
3:	8.4	→																																																																									
4:	7.8	→																																																																									
5:	8.5	↑																																																																									
6:	7.8	↗																																																																									
7:	8.8	↙																																																																									
8:	8.8	↗																																																																									
9:	10.6x	↗																																																																									
10:	10.4x	←																																																																									
<b>Serie</b>		83.0																																																																									
<b>Total</b>		83.0																																																																									
11:	8.9	↗																																																																									
12:	9.3	↖																																																																									
13:	7.4	←																																																																									
14:	9.1	→																																																																									
15:	9.2	↘																																																																									
16:	7.9	↗																																																																									
17:	8.1	↑																																																																									
18:	9.2	↙																																																																									
19:	9.8	↗																																																																									
20:	8.7	←																																																																									
<b>Serie</b>		83.0																																																																									
<b>Total</b>		166.0																																																																									
<b>60 Skud</b> 	<table border="1" style="width:100%; border-collapse: collapse;"> <tr><td>21:</td><td>8.2</td><td>↖</td></tr> <tr><td>22:</td><td>9.7</td><td>↖</td></tr> <tr><td>23:</td><td>9.5</td><td>↘</td></tr> <tr><td>24:</td><td>10.1</td><td>↙</td></tr> <tr><td>25:</td><td>10.5x</td><td>↙</td></tr> <tr><td>26:</td><td>10.0</td><td>↗</td></tr> <tr><td>27:</td><td>10.4x</td><td>→</td></tr> <tr><td>28:</td><td>10.5x</td><td>↑</td></tr> <tr><td>29:</td><td>10.7x</td><td>↑</td></tr> <tr><td>30:</td><td>9.7</td><td>↘</td></tr> <tr><td colspan="2"><b>Serie</b></td><td>95.0</td></tr> <tr><td colspan="2"><b>Total</b></td><td>261.0</td></tr> </table>	21:	8.2	↖	22:	9.7	↖	23:	9.5	↘	24:	10.1	↙	25:	10.5x	↙	26:	10.0	↗	27:	10.4x	→	28:	10.5x	↑	29:	10.7x	↑	30:	9.7	↘	<b>Serie</b>		95.0	<b>Total</b>		261.0	<b>60 Skud</b> 	<table border="1" style="width:100%; border-collapse: collapse;"> <tr><td>31:</td><td>9.0</td><td>↑</td></tr> <tr><td>32:</td><td>8.3</td><td>↗</td></tr> <tr><td>33:</td><td>9.9</td><td>←</td></tr> <tr><td>34:</td><td>9.1</td><td>↑</td></tr> <tr><td>35:</td><td>10.1</td><td>↘</td></tr> <tr><td>36:</td><td>9.4</td><td>←</td></tr> <tr><td>37:</td><td>10.2</td><td>↗</td></tr> <tr><td>38:</td><td>10.6x</td><td>↑</td></tr> <tr><td>39:</td><td>10.2</td><td>↘</td></tr> <tr><td>40:</td><td>9.0</td><td>←</td></tr> <tr><td colspan="2"><b>Serie</b></td><td>93.0</td></tr> <tr><td colspan="2"><b>Total</b></td><td>354.0</td></tr> </table>	31:	9.0	↑	32:	8.3	↗	33:	9.9	←	34:	9.1	↑	35:	10.1	↘	36:	9.4	←	37:	10.2	↗	38:	10.6x	↑	39:	10.2	↘	40:	9.0	←	<b>Serie</b>		93.0	<b>Total</b>		354.0
21:	8.2	↖																																																																									
22:	9.7	↖																																																																									
23:	9.5	↘																																																																									
24:	10.1	↙																																																																									
25:	10.5x	↙																																																																									
26:	10.0	↗																																																																									
27:	10.4x	→																																																																									
28:	10.5x	↑																																																																									
29:	10.7x	↑																																																																									
30:	9.7	↘																																																																									
<b>Serie</b>		95.0																																																																									
<b>Total</b>		261.0																																																																									
31:	9.0	↑																																																																									
32:	8.3	↗																																																																									
33:	9.9	←																																																																									
34:	9.1	↑																																																																									
35:	10.1	↘																																																																									
36:	9.4	←																																																																									
37:	10.2	↗																																																																									
38:	10.6x	↑																																																																									
39:	10.2	↘																																																																									
40:	9.0	←																																																																									
<b>Serie</b>		93.0																																																																									
<b>Total</b>		354.0																																																																									
<b>60 Skud</b> 	<table border="1" style="width:100%; border-collapse: collapse;"> <tr><td>41:</td><td>10.6x</td><td>↗</td></tr> <tr><td>42:</td><td>9.6</td><td>←</td></tr> <tr><td>43:</td><td>7.9</td><td>↗</td></tr> <tr><td>44:</td><td>10.2</td><td>↖</td></tr> <tr><td>45:</td><td>9.4</td><td>↘</td></tr> <tr><td>46:</td><td>10.9x</td><td>↗</td></tr> <tr><td>47:</td><td>8.7</td><td>↗</td></tr> <tr><td>48:</td><td>9.8</td><td>↗</td></tr> <tr><td>49:</td><td>8.2</td><td>←</td></tr> <tr><td>50:</td><td>9.4</td><td>↑</td></tr> <tr><td colspan="2"><b>Serie</b></td><td>89.0</td></tr> <tr><td colspan="2"><b>Total</b></td><td>443.0</td></tr> </table>	41:	10.6x	↗	42:	9.6	←	43:	7.9	↗	44:	10.2	↖	45:	9.4	↘	46:	10.9x	↗	47:	8.7	↗	48:	9.8	↗	49:	8.2	←	50:	9.4	↑	<b>Serie</b>		89.0	<b>Total</b>		443.0	<b>60 Skud</b> 	<table border="1" style="width:100%; border-collapse: collapse;"> <tr><td>51:</td><td>10.2</td><td>↖</td></tr> <tr><td>52:</td><td>9.5</td><td>←</td></tr> <tr><td>53:</td><td>9.0</td><td>↖</td></tr> <tr><td>54:</td><td>10.2</td><td>↘</td></tr> <tr><td>55:</td><td>9.3</td><td>↑</td></tr> <tr><td>56:</td><td>9.5</td><td>←</td></tr> <tr><td>57:</td><td>10.4x</td><td>↗</td></tr> <tr><td>58:</td><td>9.9</td><td>↘</td></tr> <tr><td>59:</td><td>7.7</td><td>←</td></tr> <tr><td>60:</td><td>10.1</td><td>↖</td></tr> <tr><td colspan="2"><b>Serie</b></td><td>92.0</td></tr> <tr><td colspan="2"><b>Total</b></td><td>535.0</td></tr> </table>	51:	10.2	↖	52:	9.5	←	53:	9.0	↖	54:	10.2	↘	55:	9.3	↑	56:	9.5	←	57:	10.4x	↗	58:	9.9	↘	59:	7.7	←	60:	10.1	↖	<b>Serie</b>		92.0	<b>Total</b>		535.0
41:	10.6x	↗																																																																									
42:	9.6	←																																																																									
43:	7.9	↗																																																																									
44:	10.2	↖																																																																									
45:	9.4	↘																																																																									
46:	10.9x	↗																																																																									
47:	8.7	↗																																																																									
48:	9.8	↗																																																																									
49:	8.2	←																																																																									
50:	9.4	↑																																																																									
<b>Serie</b>		89.0																																																																									
<b>Total</b>		443.0																																																																									
51:	10.2	↖																																																																									
52:	9.5	←																																																																									
53:	9.0	↖																																																																									
54:	10.2	↘																																																																									
55:	9.3	↑																																																																									
56:	9.5	←																																																																									
57:	10.4x	↗																																																																									
58:	9.9	↘																																																																									
59:	7.7	←																																																																									
60:	10.1	↖																																																																									
<b>Serie</b>		92.0																																																																									
<b>Total</b>		535.0																																																																									

Hold	Skive	Laila Højfeldt			
70	3	Vesterkæret	Vejle Skytteforening		
		D	P		
		10 meter luftstævne 2015	Aalborg Skyttekreds		
Prøve		1: 9.3 ↑ 2: 10.7x↑ 3: 9.6 ← 4: 10.1 → 5: 10.8x← 6: 10.6x← 7: 9.3 → 8: 9.6 ← 9: 10.0 ↑ 10: 10.7x↑ Serie 96.0 Total 0.0	Prøve		11: 9.8 ↖ 12: 9.1 ↑ 13: 8.9 → 14: 9.8 ← 15: 8.5 ↙ 16: 9.9 ↘ Serie 52.0 Total 0.0
40 Skud		1: 9.3 ← 2: 9.0 ← 3: 10.5x← 4: 9.3 ↑ 5: 10.1 ↘ 6: 9.9 ↗ 7: 9.4 ↘ 8: 9.8 ← 9: 8.8 → 10: 10.4x↗ Serie 92.0 Total 92.0	40 Skud		11: 9.3 ↗ 12: 10.6x↘ 13: 10.7x↗ 14: 10.3 → 15: 9.7 ← 16: 9.9 ↘ 17: 7.1 → 18: 9.6 ← 19: 9.5 ↘ 20: 9.7 ↘ Serie 91.0 Total 183.0
40 Skud		21: 9.5 ↘ 22: 9.9 ↗ 23: 8.9 → 24: 10.5x↘ 25: 9.8 ← 26: 9.4 ↑ 27: 10.5x← 28: 8.6 ↘ 29: 10.0 ↑ 30: 9.1 → Serie 91.0 Total 274.0	40 Skud		31: 9.5 ↑ 32: 9.3 ↘ 33: 9.6 ↑ 34: 10.4x↘ 35: 8.7 ↗ 36: 10.5x↘ 37: 9.5 ↑ 38: 9.5 → 39: 9.6 ↘ 40: 9.2 ← Serie 91.0 Total 365.0

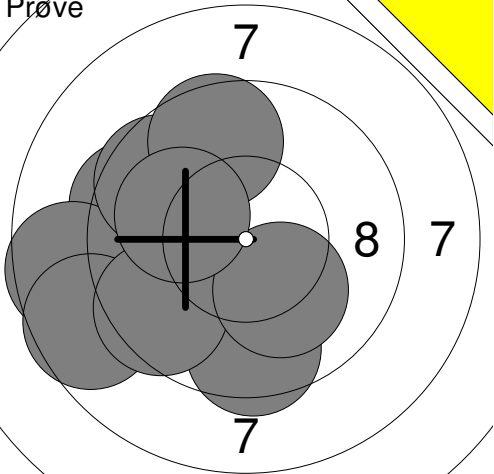
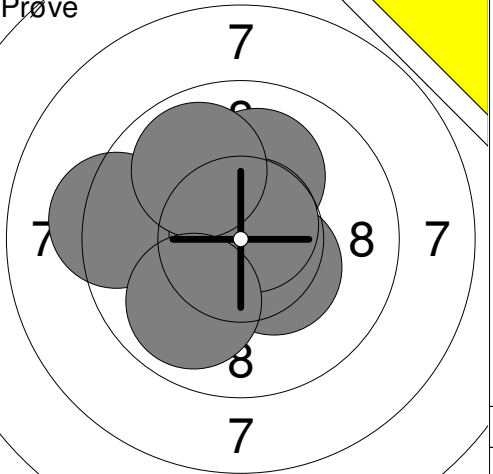
<b>Prøve</b> 	1: 9.4 ← 2: 8.6 ← 3: 9.6 ↗ 4: 9.7 ↙ 5: 8.6 ← 6: 9.5 ↓ 7: 9.5 ↙ 8: 9.6 ↑ 9: 10.1 ↘ 10: 10.1 ↖ <hr/> Serie 94.7 Total 0.0	<b>Prøve</b> 	11: 9.3 ← 12: 10.9x ↗ 13: 10.1 ↑ 14: 10.4x ↘ 15: 10.7x ↗ 16: 9.9 ↗ 17: 9.9 ↘ <hr/> Serie 71.2 Total 0.0
--	--	--	---

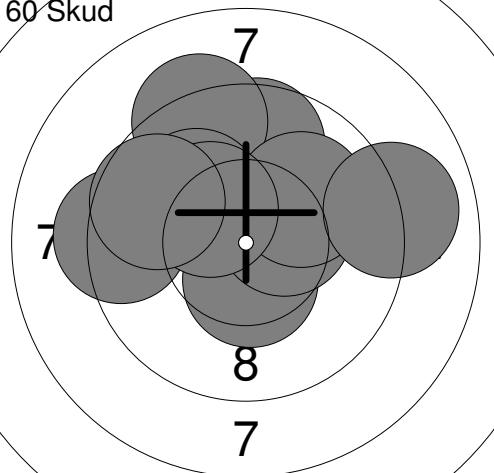
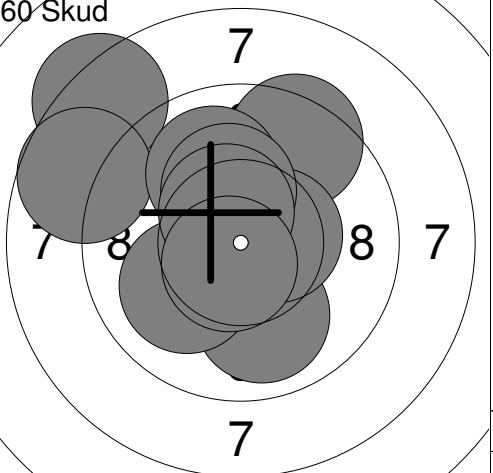
<b>60 Skud</b> 	1: 9.7 ↑ 2: 9.3 ← 3: 9.2 ↑ 4: 10.5x ↓ 5: 10.4x → 6: 10.0 ↗ 7: 10.1 ↗ 8: 10.3x ↗ 9: 9.0 → 10: 9.7 ↗ <hr/> Serie 98.2 Total 98.2	<b>60 Skud</b> 	11: 8.3 ↘ 12: 8.7 ← 13: 9.4 ↗ 14: 10.0 ↗ 15: 10.0 ↓ 16: 10.5x → 17: 10.2x ↑ 18: 10.0 ↙ 19: 10.5x ↗ 20: 10.6x ↘ <hr/> Serie 98.2 Total 196.4
---	---	---	--

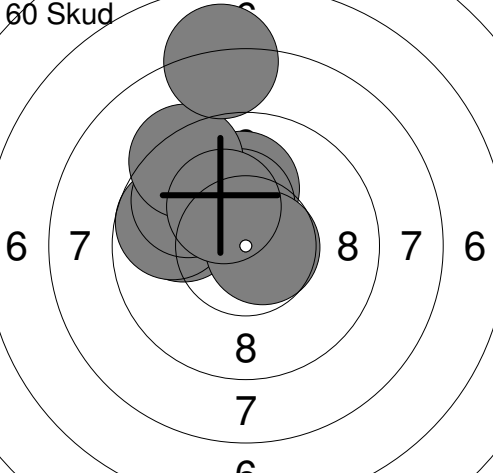
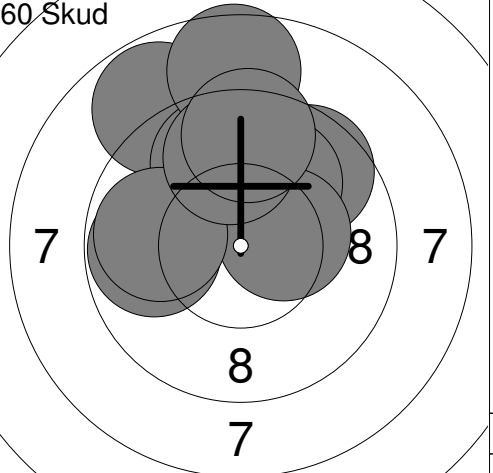
<b>60 Skud</b> 	21: 10.0 ↗ 22: 9.9 ← 23: 9.7 ← 24: 10.0 ↑ 25: 10.3x ↑ 26: 9.8 ↗ 27: 9.3 ↗ 28: 10.7x → 29: 10.2x ↗ 30: 8.0 ↑ <hr/> Serie 97.9 Total 294.3	<b>60 Skud</b> 	31: 9.6 ↗ 32: 8.8 ↗ 33: 9.8 ↑ 34: 10.0 ↗ 35: 10.3x → 36: 9.8 ← 37: 9.9 ← 38: 8.6 ↑ 39: 9.8 ↑ 40: 9.5 ↑ <hr/> Serie 96.1 Total 390.4
--	---	--	--

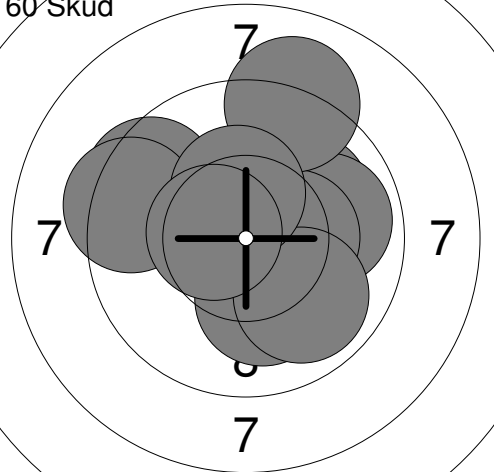
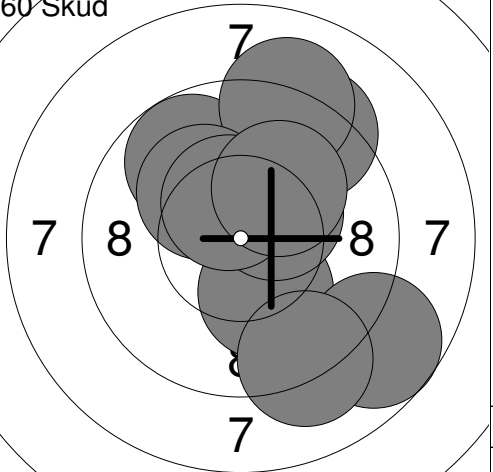
<b>60 Skud</b> 	41: 10.0 ↗ 42: 9.5 ↗ 43: 9.9 → 44: 10.3x → 45: 10.1 ↓ 46: 9.9 ↘ 47: 9.1 ↗ 48: 9.4 ← 49: 10.3x ↑ 50: 10.5x ← <hr/> Serie 99.0 Total 489.4	<b>60 Skud</b> 	51: 9.3 ↗ 52: 9.8 ↗ 53: 9.1 ↗ 54: 10.2x ↗ 55: 10.2x ↓ 56: 10.4x ↗ 57: 8.7 ↘ 58: 10.5x ↗ 59: 10.1 ↗ 60: 9.1 ↓ <hr/> Serie 97.4 Total 586.8
--	---	--	--

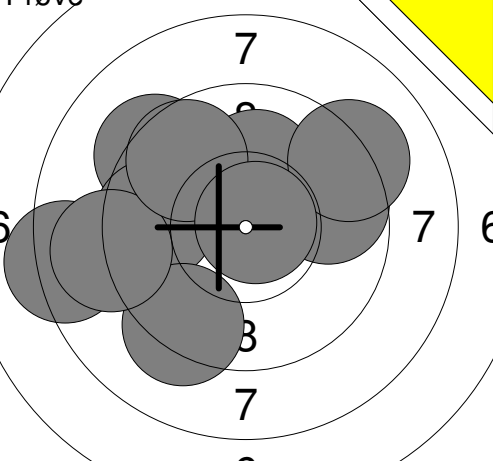
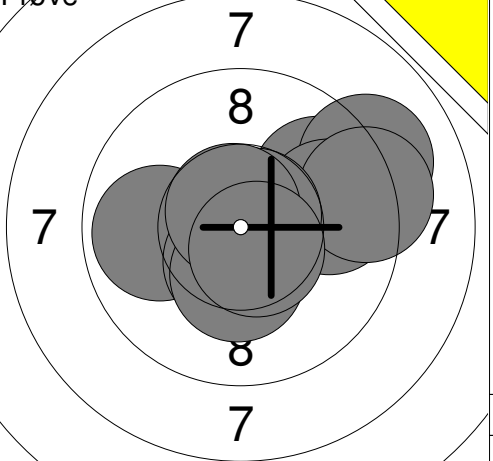
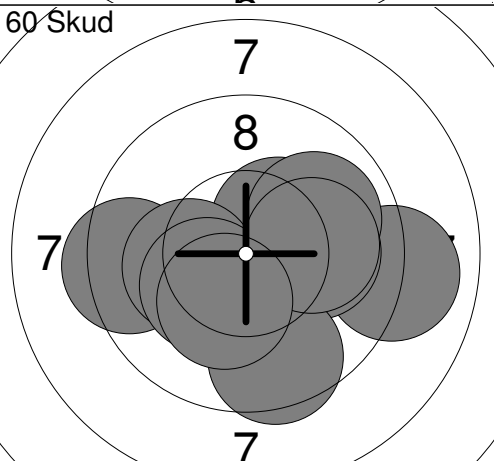
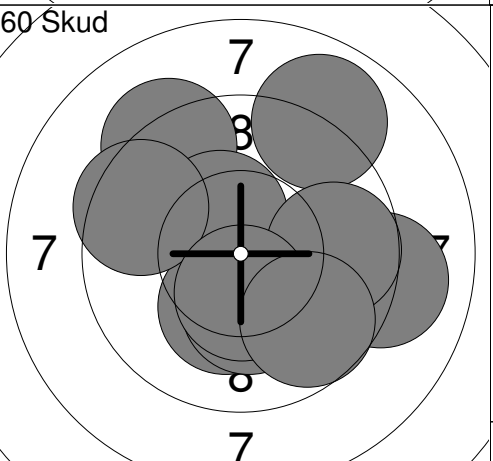
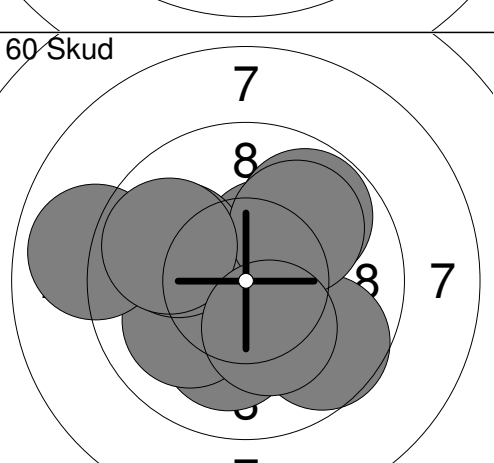
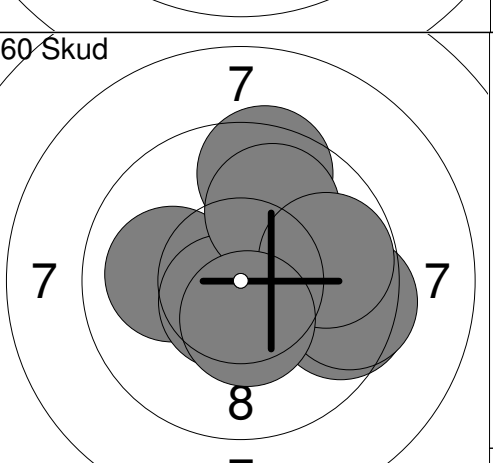
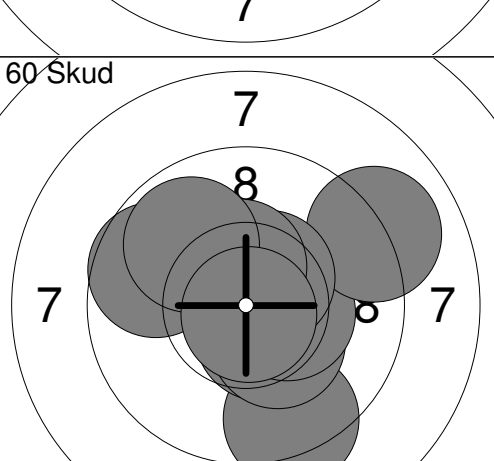
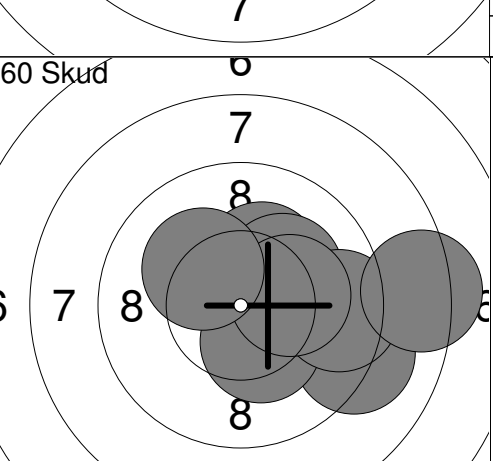

<p>Prøve</p> 	<table border="1" style="width:100%; border-collapse: collapse;"> <tr><td>1:</td><td>9.3</td><td>↖</td></tr> <tr><td>2:</td><td>9.7</td><td>→</td></tr> <tr><td>3:</td><td>10.1</td><td>↑</td></tr> <tr><td>4:</td><td>9.6</td><td>←</td></tr> <tr><td>5:</td><td>8.3</td><td>←</td></tr> <tr><td>6:</td><td>9.3</td><td>↙</td></tr> <tr><td>7:</td><td>9.0</td><td>←</td></tr> <tr><td>8:</td><td>9.6</td><td>↗</td></tr> <tr><td>9:</td><td>9.2</td><td>↗</td></tr> <tr><td>10:</td><td>10.8x</td><td>↗</td></tr> <tr><td colspan="2">Serie</td><td>94.9</td></tr> <tr><td colspan="2">Total</td><td>0.0</td></tr> </table>	1:	9.3	↖	2:	9.7	→	3:	10.1	↑	4:	9.6	←	5:	8.3	←	6:	9.3	↙	7:	9.0	←	8:	9.6	↗	9:	9.2	↗	10:	10.8x	↗	Serie		94.9	Total		0.0	<p>Prøve</p>  <table border="1" style="width:100%; border-collapse: collapse;"> <tr><td>11:</td><td>9.8</td><td>↗</td></tr> <tr><td>12:</td><td>9.1</td><td>↗</td></tr> <tr><td>13:</td><td>9.7</td><td>→</td></tr> <tr><td>14:</td><td>9.9</td><td>←</td></tr> <tr><td>15:</td><td>10.5x</td><td>↘</td></tr> <tr><td>16:</td><td>9.2</td><td>→</td></tr> <tr><td>17:</td><td>10.7x</td><td>↗</td></tr> <tr><td>18:</td><td>10.3x</td><td>↘</td></tr> <tr><td>19:</td><td>10.7x</td><td>↗</td></tr> <tr><td>20:</td><td>10.6x</td><td>↘</td></tr> <tr><td colspan="2">Serie</td><td>100.5</td></tr> <tr><td colspan="2">Total</td><td>0.0</td></tr> </table>	11:	9.8	↗	12:	9.1	↗	13:	9.7	→	14:	9.9	←	15:	10.5x	↘	16:	9.2	→	17:	10.7x	↗	18:	10.3x	↘	19:	10.7x	↗	20:	10.6x	↘	Serie		100.5	Total		0.0
1:	9.3	↖																																																																								
2:	9.7	→																																																																								
3:	10.1	↑																																																																								
4:	9.6	←																																																																								
5:	8.3	←																																																																								
6:	9.3	↙																																																																								
7:	9.0	←																																																																								
8:	9.6	↗																																																																								
9:	9.2	↗																																																																								
10:	10.8x	↗																																																																								
Serie		94.9																																																																								
Total		0.0																																																																								
11:	9.8	↗																																																																								
12:	9.1	↗																																																																								
13:	9.7	→																																																																								
14:	9.9	←																																																																								
15:	10.5x	↘																																																																								
16:	9.2	→																																																																								
17:	10.7x	↗																																																																								
18:	10.3x	↘																																																																								
19:	10.7x	↗																																																																								
20:	10.6x	↘																																																																								
Serie		100.5																																																																								
Total		0.0																																																																								
<p>60 Skud</p> 	<table border="1" style="width:100%; border-collapse: collapse;"> <tr><td>1:</td><td>9.0</td><td>→</td></tr> <tr><td>2:</td><td>10.4x</td><td>↗</td></tr> <tr><td>3:</td><td>9.9</td><td>↗</td></tr> <tr><td>4:</td><td>9.4</td><td>←</td></tr> <tr><td>5:</td><td>10.2x</td><td>←</td></tr> <tr><td>6:</td><td>10.3x</td><td>↙</td></tr> <tr><td>7:</td><td>10.1</td><td>→</td></tr> <tr><td>8:</td><td>9.5</td><td>↘</td></tr> <tr><td>9:</td><td>10.1</td><td>→</td></tr> <tr><td>10:</td><td>10.3x</td><td>↘</td></tr> <tr><td colspan="2">Serie</td><td>99.2</td></tr> <tr><td colspan="2">Total</td><td>99.2</td></tr> </table>	1:	9.0	→	2:	10.4x	↗	3:	9.9	↗	4:	9.4	←	5:	10.2x	←	6:	10.3x	↙	7:	10.1	→	8:	9.5	↘	9:	10.1	→	10:	10.3x	↘	Serie		99.2	Total		99.2	<p>60 Skud</p>  <table border="1" style="width:100%; border-collapse: collapse;"> <tr><td>11:</td><td>9.2</td><td>↖</td></tr> <tr><td>12:</td><td>9.1</td><td>→</td></tr> <tr><td>13:</td><td>8.9</td><td>↗</td></tr> <tr><td>14:</td><td>10.4x</td><td>↗</td></tr> <tr><td>15:</td><td>10.2x</td><td>↘</td></tr> <tr><td>16:</td><td>10.2x</td><td>↘</td></tr> <tr><td>17:</td><td>9.5</td><td>↖</td></tr> <tr><td>18:</td><td>9.7</td><td>→</td></tr> <tr><td>19:</td><td>10.4x</td><td>↘</td></tr> <tr><td>20:</td><td>9.7</td><td>↘</td></tr> <tr><td colspan="2">Serie</td><td>97.3</td></tr> <tr><td colspan="2">Total</td><td>196.5</td></tr> </table>	11:	9.2	↖	12:	9.1	→	13:	8.9	↗	14:	10.4x	↗	15:	10.2x	↘	16:	10.2x	↘	17:	9.5	↖	18:	9.7	→	19:	10.4x	↘	20:	9.7	↘	Serie		97.3	Total		196.5
1:	9.0	→																																																																								
2:	10.4x	↗																																																																								
3:	9.9	↗																																																																								
4:	9.4	←																																																																								
5:	10.2x	←																																																																								
6:	10.3x	↙																																																																								
7:	10.1	→																																																																								
8:	9.5	↘																																																																								
9:	10.1	→																																																																								
10:	10.3x	↘																																																																								
Serie		99.2																																																																								
Total		99.2																																																																								
11:	9.2	↖																																																																								
12:	9.1	→																																																																								
13:	8.9	↗																																																																								
14:	10.4x	↗																																																																								
15:	10.2x	↘																																																																								
16:	10.2x	↘																																																																								
17:	9.5	↖																																																																								
18:	9.7	→																																																																								
19:	10.4x	↘																																																																								
20:	9.7	↘																																																																								
Serie		97.3																																																																								
Total		196.5																																																																								
<p>60 Skud</p> 	<table border="1" style="width:100%; border-collapse: collapse;"> <tr><td>21:</td><td>9.7</td><td>↘</td></tr> <tr><td>22:</td><td>10.1</td><td>↘</td></tr> <tr><td>23:</td><td>10.0</td><td>↙</td></tr> <tr><td>24:</td><td>10.4x</td><td>↗</td></tr> <tr><td>25:</td><td>9.8</td><td>↗</td></tr> <tr><td>26:</td><td>10.0</td><td>↖</td></tr> <tr><td>27:</td><td>10.0</td><td>↗</td></tr> <tr><td>28:</td><td>8.9</td><td>←</td></tr> <tr><td>29:</td><td>9.8</td><td>←</td></tr> <tr><td>30:</td><td>10.3x</td><td>↘</td></tr> <tr><td colspan="2">Serie</td><td>99.0</td></tr> <tr><td colspan="2">Total</td><td>295.5</td></tr> </table>	21:	9.7	↘	22:	10.1	↘	23:	10.0	↙	24:	10.4x	↗	25:	9.8	↗	26:	10.0	↖	27:	10.0	↗	28:	8.9	←	29:	9.8	←	30:	10.3x	↘	Serie		99.0	Total		295.5	<p>60 Skud</p>  <table border="1" style="width:100%; border-collapse: collapse;"> <tr><td>31:</td><td>9.6</td><td>→</td></tr> <tr><td>32:</td><td>10.0</td><td>←</td></tr> <tr><td>33:</td><td>10.6x</td><td>→</td></tr> <tr><td>34:</td><td>10.1</td><td>→</td></tr> <tr><td>35:</td><td>9.5</td><td>→</td></tr> <tr><td>36:</td><td>9.5</td><td>↑</td></tr> <tr><td>37:</td><td>10.6x</td><td>↘</td></tr> <tr><td>38:</td><td>9.9</td><td>↗</td></tr> <tr><td>39:</td><td>9.8</td><td>→</td></tr> <tr><td>40:</td><td>10.4x</td><td>↘</td></tr> <tr><td colspan="2">Serie</td><td>100.0</td></tr> <tr><td colspan="2">Total</td><td>395.5</td></tr> </table>	31:	9.6	→	32:	10.0	←	33:	10.6x	→	34:	10.1	→	35:	9.5	→	36:	9.5	↑	37:	10.6x	↘	38:	9.9	↗	39:	9.8	→	40:	10.4x	↘	Serie		100.0	Total		395.5
21:	9.7	↘																																																																								
22:	10.1	↘																																																																								
23:	10.0	↙																																																																								
24:	10.4x	↗																																																																								
25:	9.8	↗																																																																								
26:	10.0	↖																																																																								
27:	10.0	↗																																																																								
28:	8.9	←																																																																								
29:	9.8	←																																																																								
30:	10.3x	↘																																																																								
Serie		99.0																																																																								
Total		295.5																																																																								
31:	9.6	→																																																																								
32:	10.0	←																																																																								
33:	10.6x	→																																																																								
34:	10.1	→																																																																								
35:	9.5	→																																																																								
36:	9.5	↑																																																																								
37:	10.6x	↘																																																																								
38:	9.9	↗																																																																								
39:	9.8	→																																																																								
40:	10.4x	↘																																																																								
Serie		100.0																																																																								
Total		395.5																																																																								
<p>60 Skud</p> 	<table border="1" style="width:100%; border-collapse: collapse;"> <tr><td>41:</td><td>9.7</td><td>←</td></tr> <tr><td>42:</td><td>9.3</td><td>↘</td></tr> <tr><td>43:</td><td>10.5x</td><td>↘</td></tr> <tr><td>44:</td><td>10.3x</td><td>↘</td></tr> <tr><td>45:</td><td>10.4x</td><td>→</td></tr> <tr><td>46:</td><td>9.0</td><td>↗</td></tr> <tr><td>47:</td><td>10.5x</td><td>↗</td></tr> <tr><td>48:</td><td>10.4x</td><td>↑</td></tr> <tr><td>49:</td><td>9.9</td><td>↗</td></tr> <tr><td>50:</td><td>10.8x</td><td>↘</td></tr> <tr><td colspan="2">Serie</td><td>100.8</td></tr> <tr><td colspan="2">Total</td><td>496.3</td></tr> </table>	41:	9.7	←	42:	9.3	↘	43:	10.5x	↘	44:	10.3x	↘	45:	10.4x	→	46:	9.0	↗	47:	10.5x	↗	48:	10.4x	↑	49:	9.9	↗	50:	10.8x	↘	Serie		100.8	Total		496.3	<p>60 Skud</p>  <table border="1" style="width:100%; border-collapse: collapse;"> <tr><td>51:</td><td>10.5x</td><td>↑</td></tr> <tr><td>52:</td><td>10.3x</td><td>↗</td></tr> <tr><td>53:</td><td>10.5x</td><td>→</td></tr> <tr><td>54:</td><td>10.2x</td><td>↗</td></tr> <tr><td>55:</td><td>9.1</td><td>↘</td></tr> <tr><td>56:</td><td>10.3x</td><td>↘</td></tr> <tr><td>57:</td><td>9.5</td><td>→</td></tr> <tr><td>58:</td><td>10.2x</td><td>→</td></tr> <tr><td>59:</td><td>8.3</td><td>→</td></tr> <tr><td>60:</td><td>10.2x</td><td>↗</td></tr> <tr><td colspan="2">Serie</td><td>99.1</td></tr> <tr><td colspan="2">Total</td><td>595.4</td></tr> </table>	51:	10.5x	↑	52:	10.3x	↗	53:	10.5x	→	54:	10.2x	↗	55:	9.1	↘	56:	10.3x	↘	57:	9.5	→	58:	10.2x	→	59:	8.3	→	60:	10.2x	↗	Serie		99.1	Total		595.4
41:	9.7	←																																																																								
42:	9.3	↘																																																																								
43:	10.5x	↘																																																																								
44:	10.3x	↘																																																																								
45:	10.4x	→																																																																								
46:	9.0	↗																																																																								
47:	10.5x	↗																																																																								
48:	10.4x	↑																																																																								
49:	9.9	↗																																																																								
50:	10.8x	↘																																																																								
Serie		100.8																																																																								
Total		496.3																																																																								
51:	10.5x	↑																																																																								
52:	10.3x	↗																																																																								
53:	10.5x	→																																																																								
54:	10.2x	↗																																																																								
55:	9.1	↘																																																																								
56:	10.3x	↘																																																																								
57:	9.5	→																																																																								
58:	10.2x	→																																																																								
59:	8.3	→																																																																								
60:	10.2x	↗																																																																								
Serie		99.1																																																																								
Total		595.4																																																																								

10 meter luftstævne 2015	Aalborg Skyttekreds
--------------------------	---------------------

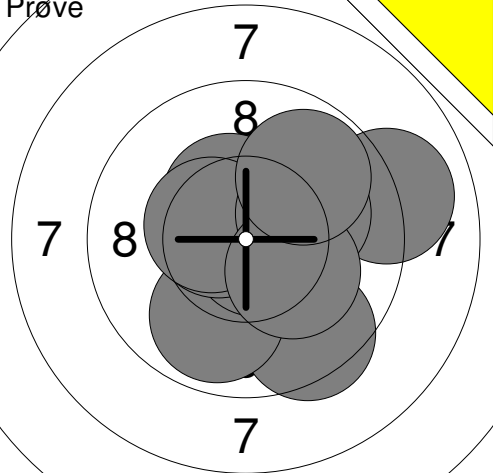
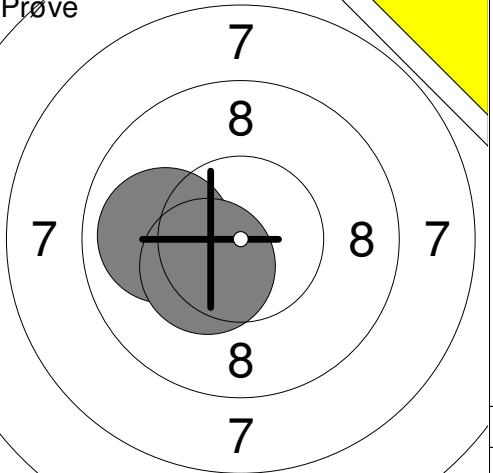
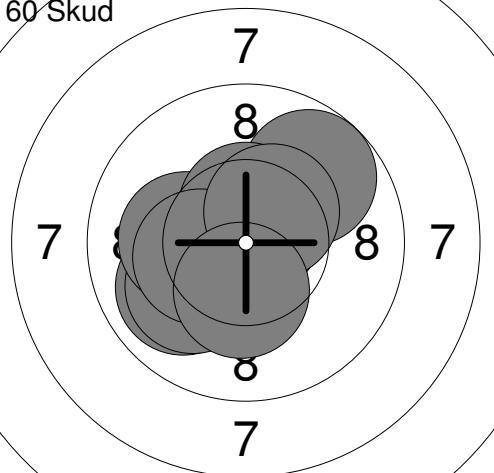
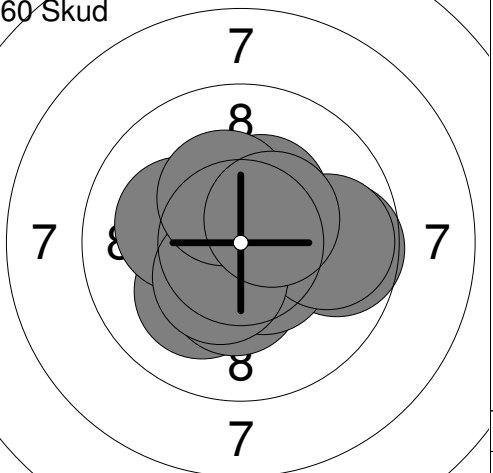
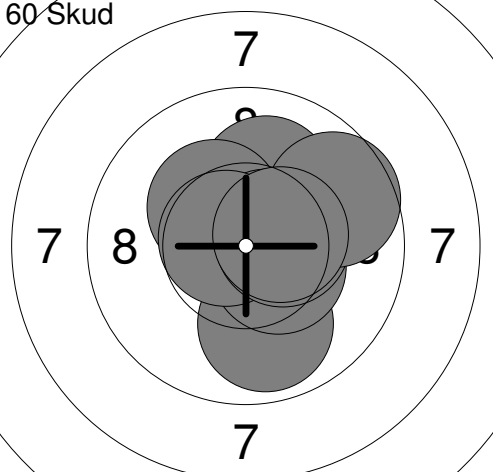
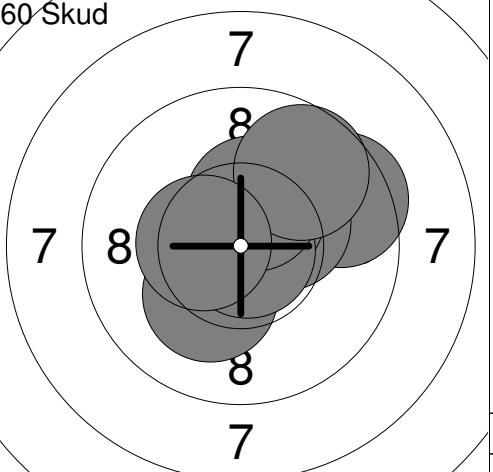
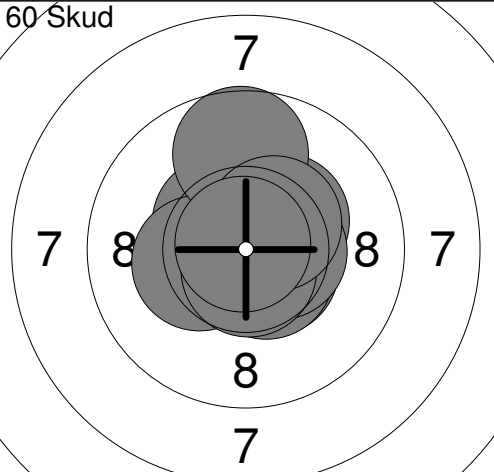
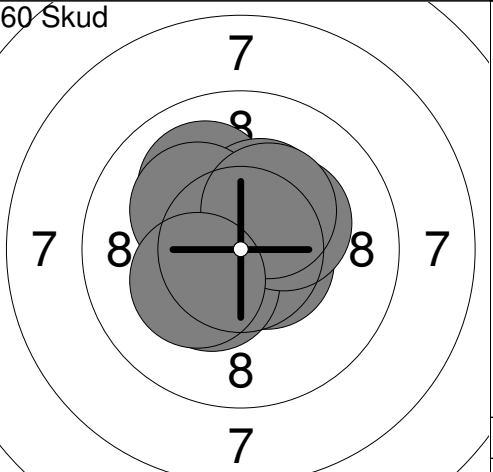
Prøve		<table border="1" style="width:100%; border-collapse: collapse;"> <tr><td>1:</td><td>9.5</td><td>↘</td></tr> <tr><td>2:</td><td>9.9</td><td>↘</td></tr> <tr><td>3:</td><td>10.4x</td><td>↗</td></tr> <tr><td>4:</td><td>10.7x</td><td>↘</td></tr> <tr><td>5:</td><td>9.0</td><td>→</td></tr> <tr><td>6:</td><td>10.6x</td><td>←</td></tr> <tr><td>7:</td><td>10.5x</td><td>↖</td></tr> <tr><td>8:</td><td>10.1</td><td>→</td></tr> <tr><td>9:</td><td>10.2x</td><td>↘</td></tr> <tr><td>10:</td><td>9.8</td><td>↗</td></tr> <tr><td colspan="2">Serie</td><td>100.7</td></tr> <tr><td colspan="2">Total</td><td>0.0</td></tr> </table>	1:	9.5	↘	2:	9.9	↘	3:	10.4x	↗	4:	10.7x	↘	5:	9.0	→	6:	10.6x	←	7:	10.5x	↖	8:	10.1	→	9:	10.2x	↘	10:	9.8	↗	Serie		100.7	Total		0.0	Prøve		<table border="1" style="width:100%; border-collapse: collapse;"> <tr><td>11:</td><td>10.0</td><td>←</td></tr> <tr><td>12:</td><td>10.4x</td><td>↘</td></tr> <tr><td colspan="2">Serie</td><td>20.4</td></tr> <tr><td colspan="2">Total</td><td>0.0</td></tr> </table>	11:	10.0	←	12:	10.4x	↘	Serie		20.4	Total		0.0																								
1:	9.5	↘																																																																											
2:	9.9	↘																																																																											
3:	10.4x	↗																																																																											
4:	10.7x	↘																																																																											
5:	9.0	→																																																																											
6:	10.6x	←																																																																											
7:	10.5x	↖																																																																											
8:	10.1	→																																																																											
9:	10.2x	↘																																																																											
10:	9.8	↗																																																																											
Serie		100.7																																																																											
Total		0.0																																																																											
11:	10.0	←																																																																											
12:	10.4x	↘																																																																											
Serie		20.4																																																																											
Total		0.0																																																																											
60 Skud		<table border="1" style="width:100%; border-collapse: collapse;"> <tr><td>1:</td><td>9.9</td><td>↙</td></tr> <tr><td>2:</td><td>10.1</td><td>↙</td></tr> <tr><td>3:</td><td>10.7x</td><td>↗</td></tr> <tr><td>4:</td><td>10.7x</td><td>↑</td></tr> <tr><td>5:</td><td>10.2x</td><td>←</td></tr> <tr><td>6:</td><td>9.8</td><td>↗</td></tr> <tr><td>7:</td><td>10.5x</td><td>↑</td></tr> <tr><td>8:</td><td>10.3x</td><td>←</td></tr> <tr><td>9:</td><td>10.4x</td><td>↗</td></tr> <tr><td>10:</td><td>10.3x</td><td>↓</td></tr> <tr><td colspan="2">Serie</td><td>102.9</td></tr> <tr><td colspan="2">Total</td><td>102.9</td></tr> </table>	1:	9.9	↙	2:	10.1	↙	3:	10.7x	↗	4:	10.7x	↑	5:	10.2x	←	6:	9.8	↗	7:	10.5x	↑	8:	10.3x	←	9:	10.4x	↗	10:	10.3x	↓	Serie		102.9	Total		102.9	60 Skud		<table border="1" style="width:100%; border-collapse: collapse;"> <tr><td>11:</td><td>10.1</td><td>↙</td></tr> <tr><td>12:</td><td>10.3x</td><td>↓</td></tr> <tr><td>13:</td><td>10.4x</td><td>↗</td></tr> <tr><td>14:</td><td>9.7</td><td>→</td></tr> <tr><td>15:</td><td>10.5x</td><td>↘</td></tr> <tr><td>16:</td><td>10.1</td><td>←</td></tr> <tr><td>17:</td><td>9.8</td><td>→</td></tr> <tr><td>18:</td><td>10.4x</td><td>↘</td></tr> <tr><td>19:</td><td>10.3x</td><td>↗</td></tr> <tr><td>20:</td><td>10.4x</td><td>↗</td></tr> <tr><td colspan="2">Serie</td><td>102.0</td></tr> <tr><td colspan="2">Total</td><td>204.9</td></tr> </table>	11:	10.1	↙	12:	10.3x	↓	13:	10.4x	↗	14:	9.7	→	15:	10.5x	↘	16:	10.1	←	17:	9.8	→	18:	10.4x	↘	19:	10.3x	↗	20:	10.4x	↗	Serie		102.0	Total		204.9
1:	9.9	↙																																																																											
2:	10.1	↙																																																																											
3:	10.7x	↗																																																																											
4:	10.7x	↑																																																																											
5:	10.2x	←																																																																											
6:	9.8	↗																																																																											
7:	10.5x	↑																																																																											
8:	10.3x	←																																																																											
9:	10.4x	↗																																																																											
10:	10.3x	↓																																																																											
Serie		102.9																																																																											
Total		102.9																																																																											
11:	10.1	↙																																																																											
12:	10.3x	↓																																																																											
13:	10.4x	↗																																																																											
14:	9.7	→																																																																											
15:	10.5x	↘																																																																											
16:	10.1	←																																																																											
17:	9.8	→																																																																											
18:	10.4x	↘																																																																											
19:	10.3x	↗																																																																											
20:	10.4x	↗																																																																											
Serie		102.0																																																																											
Total		204.9																																																																											
60 Skud		<table border="1" style="width:100%; border-collapse: collapse;"> <tr><td>21:</td><td>10.1</td><td>↑</td></tr> <tr><td>22:</td><td>10.6x</td><td>↗</td></tr> <tr><td>23:</td><td>10.3x</td><td>↗</td></tr> <tr><td>24:</td><td>10.6x</td><td>→</td></tr> <tr><td>25:</td><td>9.9</td><td>↘</td></tr> <tr><td>26:</td><td>10.4x</td><td>↘</td></tr> <tr><td>27:</td><td>10.7x</td><td>↖</td></tr> <tr><td>28:</td><td>10.5x</td><td>→</td></tr> <tr><td>29:</td><td>9.6</td><td>↗</td></tr> <tr><td>30:</td><td>10.5x</td><td>→</td></tr> <tr><td colspan="2">Serie</td><td>103.2</td></tr> <tr><td colspan="2">Total</td><td>308.1</td></tr> </table>	21:	10.1	↑	22:	10.6x	↗	23:	10.3x	↗	24:	10.6x	→	25:	9.9	↘	26:	10.4x	↘	27:	10.7x	↖	28:	10.5x	→	29:	9.6	↗	30:	10.5x	→	Serie		103.2	Total		308.1	60 Skud		<table border="1" style="width:100%; border-collapse: collapse;"> <tr><td>31:</td><td>10.4x</td><td>↗</td></tr> <tr><td>32:</td><td>10.3x</td><td>↗</td></tr> <tr><td>33:</td><td>10.2x</td><td>↘</td></tr> <tr><td>34:</td><td>9.5</td><td>↗</td></tr> <tr><td>35:</td><td>10.3x</td><td>↗</td></tr> <tr><td>36:</td><td>10.5x</td><td>↗</td></tr> <tr><td>37:</td><td>10.8x</td><td>↘</td></tr> <tr><td>38:</td><td>10.4x</td><td>↑</td></tr> <tr><td>39:</td><td>9.7</td><td>↗</td></tr> <tr><td>40:</td><td>10.5x</td><td>←</td></tr> <tr><td colspan="2">Serie</td><td>102.6</td></tr> <tr><td colspan="2">Total</td><td>410.7</td></tr> </table>	31:	10.4x	↗	32:	10.3x	↗	33:	10.2x	↘	34:	9.5	↗	35:	10.3x	↗	36:	10.5x	↗	37:	10.8x	↘	38:	10.4x	↑	39:	9.7	↗	40:	10.5x	←	Serie		102.6	Total		410.7
21:	10.1	↑																																																																											
22:	10.6x	↗																																																																											
23:	10.3x	↗																																																																											
24:	10.6x	→																																																																											
25:	9.9	↘																																																																											
26:	10.4x	↘																																																																											
27:	10.7x	↖																																																																											
28:	10.5x	→																																																																											
29:	9.6	↗																																																																											
30:	10.5x	→																																																																											
Serie		103.2																																																																											
Total		308.1																																																																											
31:	10.4x	↗																																																																											
32:	10.3x	↗																																																																											
33:	10.2x	↘																																																																											
34:	9.5	↗																																																																											
35:	10.3x	↗																																																																											
36:	10.5x	↗																																																																											
37:	10.8x	↘																																																																											
38:	10.4x	↑																																																																											
39:	9.7	↗																																																																											
40:	10.5x	←																																																																											
Serie		102.6																																																																											
Total		410.7																																																																											
60 Skud		<table border="1" style="width:100%; border-collapse: collapse;"> <tr><td>41:</td><td>10.5x</td><td>↘</td></tr> <tr><td>42:</td><td>10.4x</td><td>↗</td></tr> <tr><td>43:</td><td>10.5x</td><td>↗</td></tr> <tr><td>44:</td><td>10.6x</td><td>↘</td></tr> <tr><td>45:</td><td>10.3x</td><td>←</td></tr> <tr><td>46:</td><td>10.5x</td><td>→</td></tr> <tr><td>47:</td><td>9.7</td><td>↑</td></tr> <tr><td>48:</td><td>10.7x</td><td>↘</td></tr> <tr><td>49:</td><td>10.4x</td><td>↗</td></tr> <tr><td>50:</td><td>10.9x</td><td>↗</td></tr> <tr><td colspan="2">Serie</td><td>104.5</td></tr> <tr><td colspan="2">Total</td><td>515.2</td></tr> </table>	41:	10.5x	↘	42:	10.4x	↗	43:	10.5x	↗	44:	10.6x	↘	45:	10.3x	←	46:	10.5x	→	47:	9.7	↑	48:	10.7x	↘	49:	10.4x	↗	50:	10.9x	↗	Serie		104.5	Total		515.2	60 Skud		<table border="1" style="width:100%; border-collapse: collapse;"> <tr><td>51:</td><td>10.0</td><td>↖</td></tr> <tr><td>52:</td><td>10.7x</td><td>↗</td></tr> <tr><td>53:</td><td>10.6x</td><td>↑</td></tr> <tr><td>54:</td><td>10.6x</td><td>→</td></tr> <tr><td>55:</td><td>10.4x</td><td>↘</td></tr> <tr><td>56:</td><td>10.3x</td><td>↗</td></tr> <tr><td>57:</td><td>10.3x</td><td>↗</td></tr> <tr><td>58:</td><td>10.2x</td><td>↖</td></tr> <tr><td>59:</td><td>10.3x</td><td>↗</td></tr> <tr><td>60:</td><td>10.3x</td><td>↘</td></tr> <tr><td colspan="2">Serie</td><td>103.7</td></tr> <tr><td colspan="2">Total</td><td>618.9</td></tr> </table>	51:	10.0	↖	52:	10.7x	↗	53:	10.6x	↑	54:	10.6x	→	55:	10.4x	↘	56:	10.3x	↗	57:	10.3x	↗	58:	10.2x	↖	59:	10.3x	↗	60:	10.3x	↘	Serie		103.7	Total		618.9
41:	10.5x	↘																																																																											
42:	10.4x	↗																																																																											
43:	10.5x	↗																																																																											
44:	10.6x	↘																																																																											
45:	10.3x	←																																																																											
46:	10.5x	→																																																																											
47:	9.7	↑																																																																											
48:	10.7x	↘																																																																											
49:	10.4x	↗																																																																											
50:	10.9x	↗																																																																											
Serie		104.5																																																																											
Total		515.2																																																																											
51:	10.0	↖																																																																											
52:	10.7x	↗																																																																											
53:	10.6x	↑																																																																											
54:	10.6x	→																																																																											
55:	10.4x	↘																																																																											
56:	10.3x	↗																																																																											
57:	10.3x	↗																																																																											
58:	10.2x	↖																																																																											
59:	10.3x	↗																																																																											
60:	10.3x	↘																																																																											
Serie		103.7																																																																											
Total		618.9																																																																											

10 meter luftstævne 2015	Aalborg Skyttekreds
--------------------------	---------------------

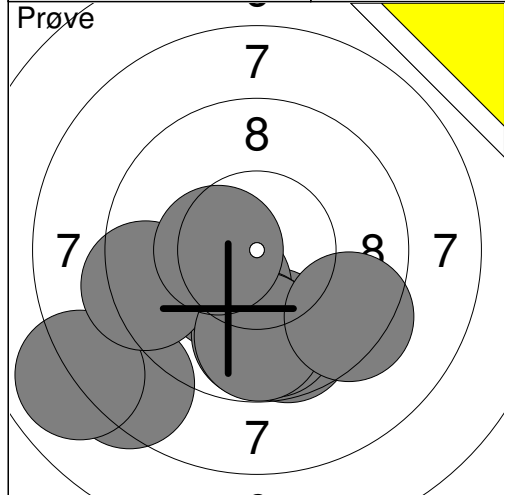

1:	9.7	↓
2:	9.8	↓
3:	8.4	↙
4:	8.0	↙
5:	10.3x	↙
6:	9.8	↓
7:	9.3	←
8:	9.8	↓
9:	9.4	↘
10:	10.4x	←
Serie		94.9
Total		0.0

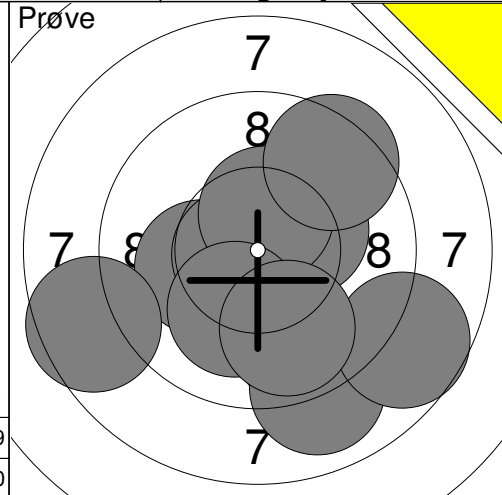

11:	10.2x	←
12:	10.7x	←
13:	10.3x	↗
14:	9.0	↓
15:	10.5x	↑
16:	8.7	↘
17:	10.1	↓
18:	8.6	←
19:	9.8	↓
20:	9.4	↗
Serie		97.3
Total		0.0

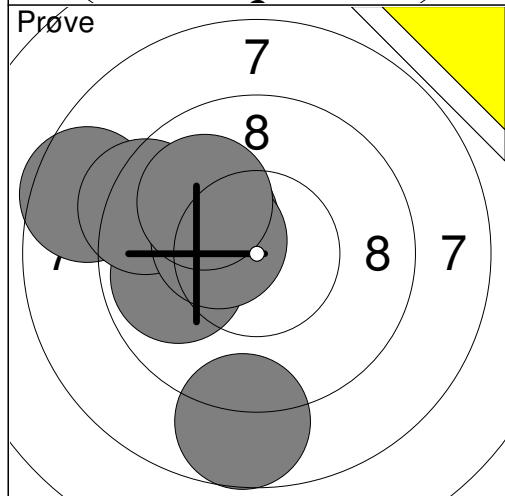

21:	9.9	←
22:	10.2x	↗
23:	8.6	↗
24:	9.4	↗
25:	8.7	↓
26:	10.4x	↗
27:	10.0	↗
Serie		67.2
Total		0.0

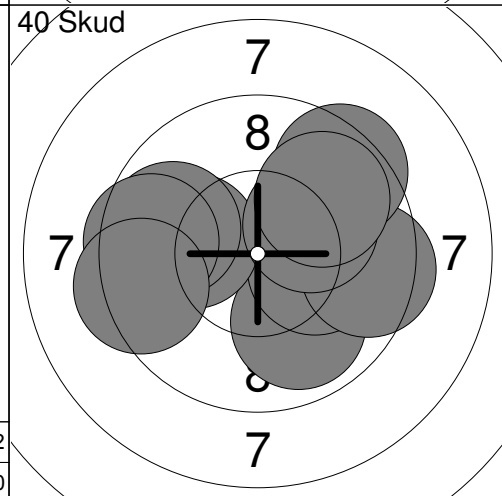

1:	9.9	↓
2:	10.2x	→
3:	9.5	→
4:	9.4	↗
5:	10.1	←
6:	9.8	←
7:	10.1	↗
8:	9.8	↗
9:	9.5	←
10:	9.4	←
Serie		97.7
Total		97.7

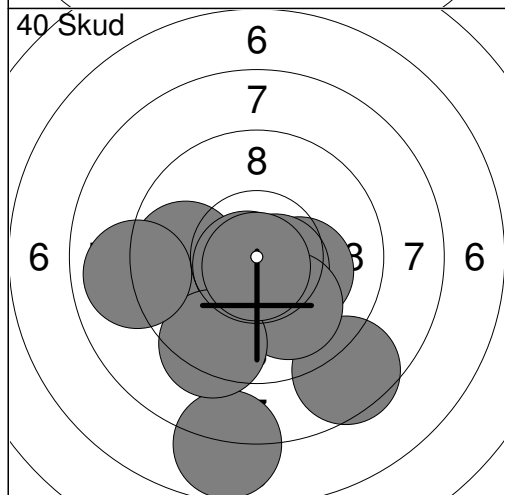

11:	10.2x	→
12:	9.8	←
13:	8.6	↓
14:	10.7x	↙
15:	10.6x	↘
16:	10.0	↓
17:	7.8	↓
18:	9.3	↓
19:	8.9	←
20:	10.8x	↓
Serie		96.7
Total		194.4

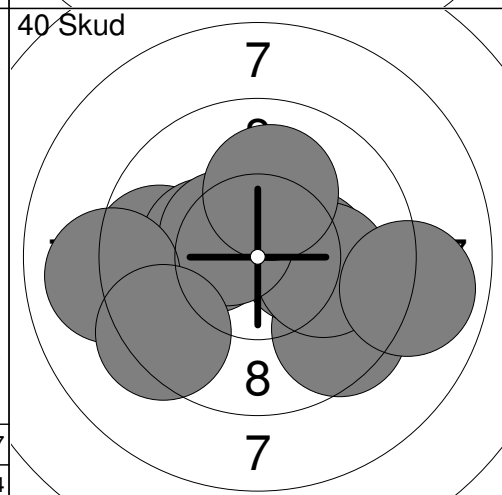

21:	9.5	↘
22:	10.3x	→
23:	9.6	←
24:	10.1	→
25:	8.9	→
26:	10.3x	←
27:	10.5x	↖
28:	9.0	←
29:	10.1	↑
30:	9.4	↙
Serie		97.7
Total		292.1

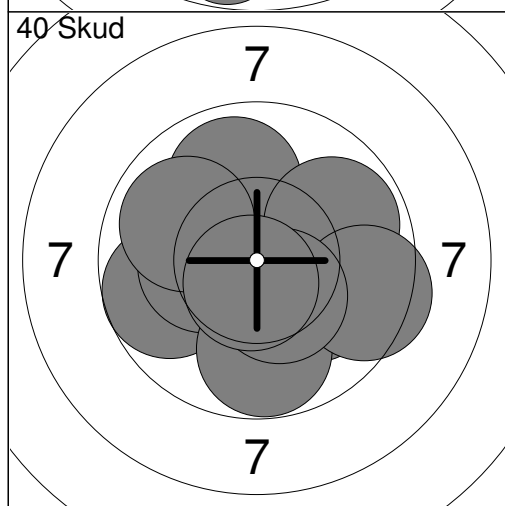

31:	9.9	↑
32:	10.1	↘
33:	9.7	←
34:	10.3x	←
35:	9.9	↗
36:	9.8	↓
37:	9.9	↗
38:	9.5	→
39:	10.4x	↓
40:	10.6x	↓
Serie		100.1
Total		392.2

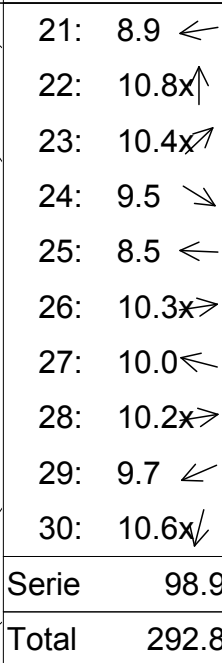
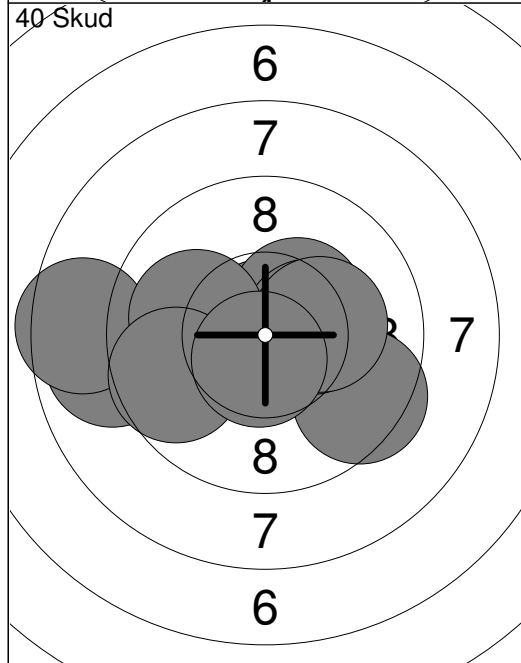
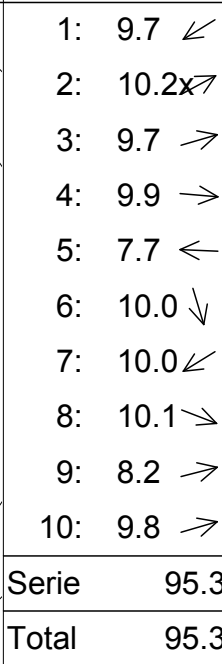
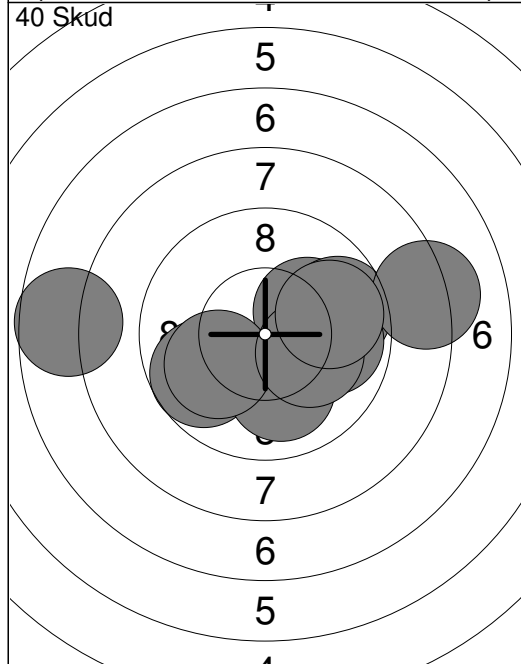
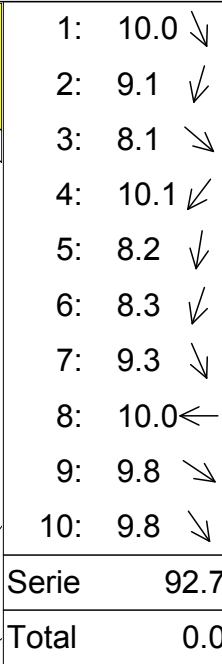
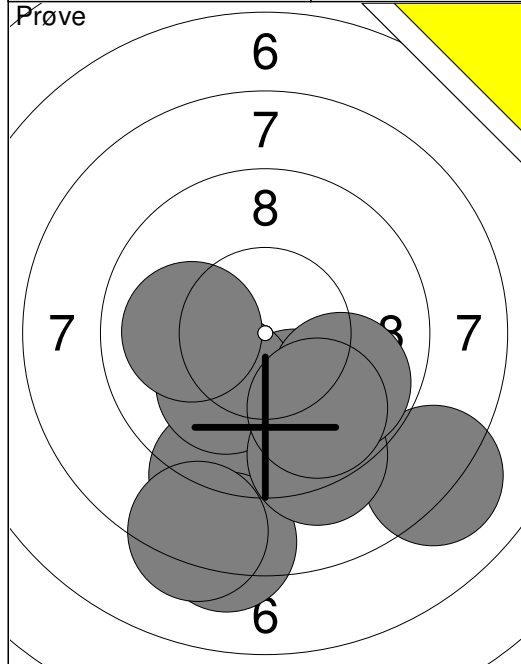

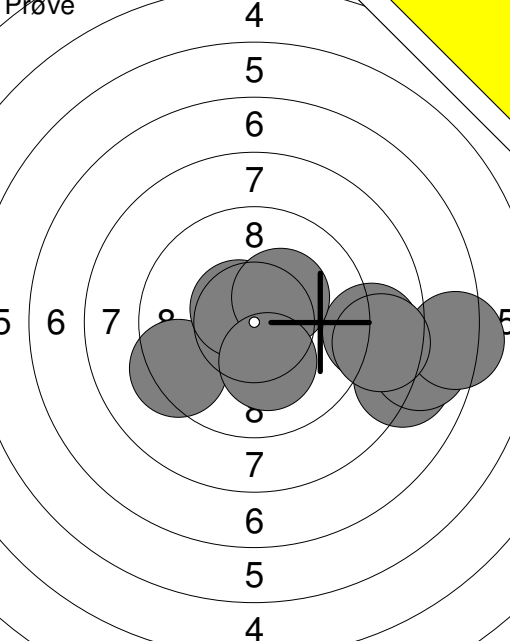
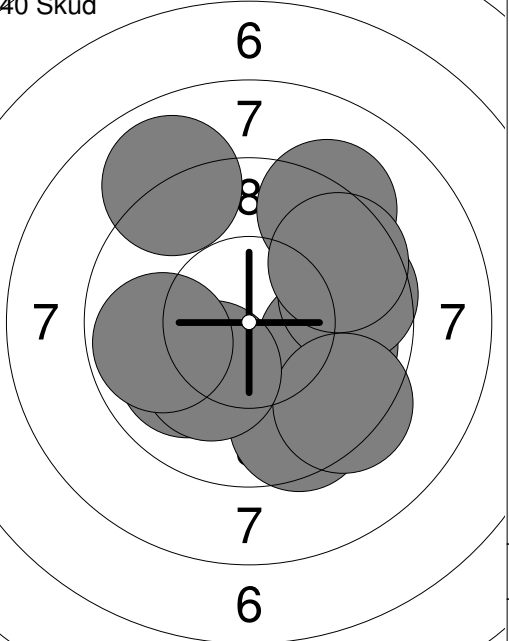
Prøve 	1: 8.1 → 2: 8.8 → 3: 9.3 ↙ 4: 7.9 → 5: 7.3 → 6: 10.6x ↘ 7: 10.3x ↗ 8: 8.6 → 9: 10.2x ↘	40 Skud 	1: 8.9 ↗ 2: 9.5 ↘ 3: 9.9 → 4: 10.0 ↙ 5: 9.6 → 6: 9.2 ↗ 7: 9.6 ↗ 8: 9.4 ↘ 9: 10.2x ↘ 10: 9.8 ←
	Serie 81.1		Serie 96.1
	Total 0.0		Total 96.1

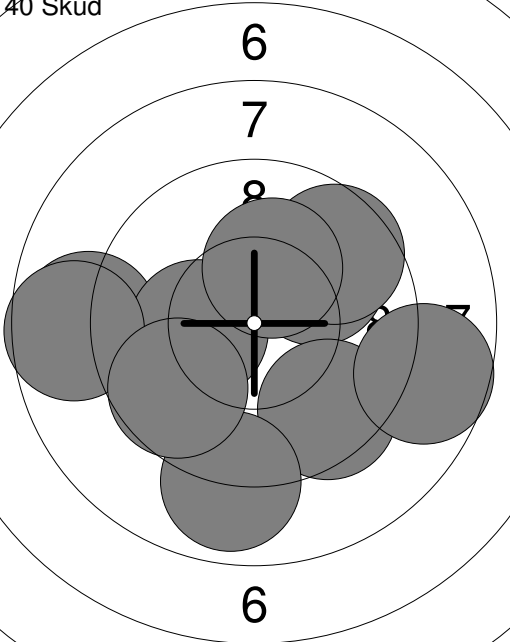
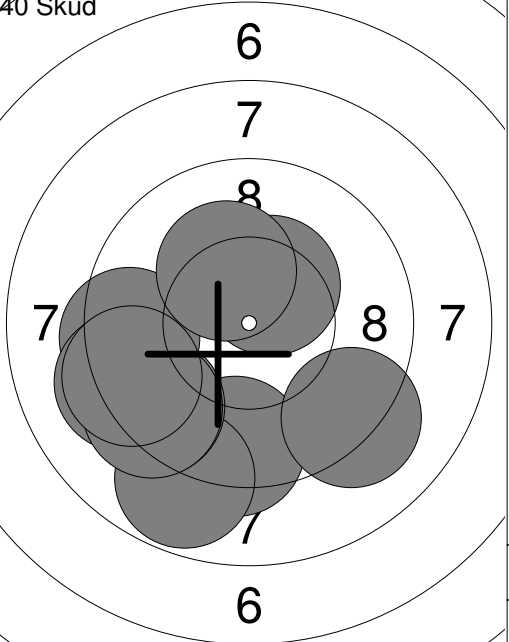
40 Skud 	11: 9.9 ↗ 12: 9.5 ↘ 13: 9.6 ↗ 14: 8.8 ← 15: 10.2x ↘ 16: 8.7 → 17: 8.9 ↘ 18: 10.2x ↗ 19: 8.6 ← 20: 9.7 ↘	40 Skud 	21: 10.4x ↗ 22: 9.4 ← 23: 9.4 ↘ 24: 8.8 ↘ 25: 9.2 ↘ 26: 9.2 ← 27: 10.2x ↘ 28: 9.3 ↘ 29: 9.3 ↘ 30: 9.3 ←
	Serie 94.1		Serie 94.5
	Total 190.2		Total 284.7

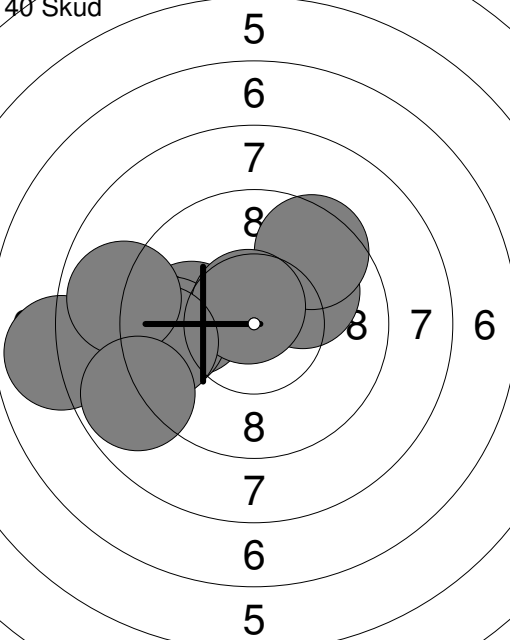
40 Skud 	31: 10.0 ↗ 32: 10.0 ← 33: 9.3 ← 34: 9.5 ↗ 35: 7.9 ← 36: 9.6 ← 37: 10.7x ↘ 38: 9.5 ← 39: 8.9 ← 40: 8.8 ↘	
	Serie 94.2	
	Total 378.9	

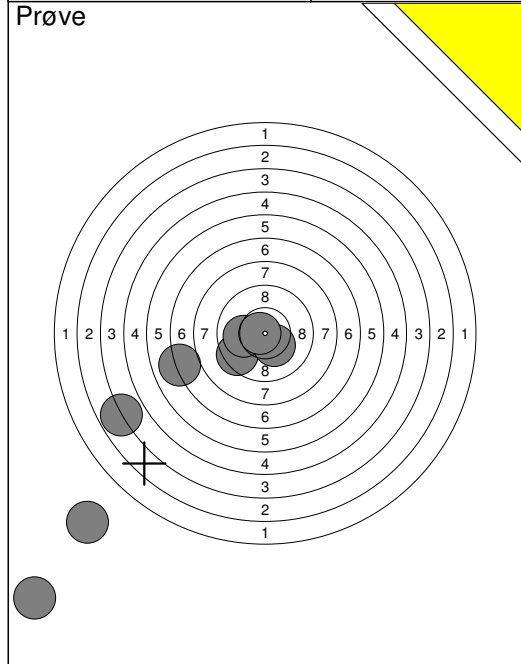

1:	0.0	↘
2:	0.0	↘
3:	0.0	↘
4:	0.0	↘
5:	3.8	↙
6:	7.0	↙
7:	9.5	↘
8:	10.0	←
9:	10.3	↘
10:	10.7	↔
Serie		51.3
Total		0.0

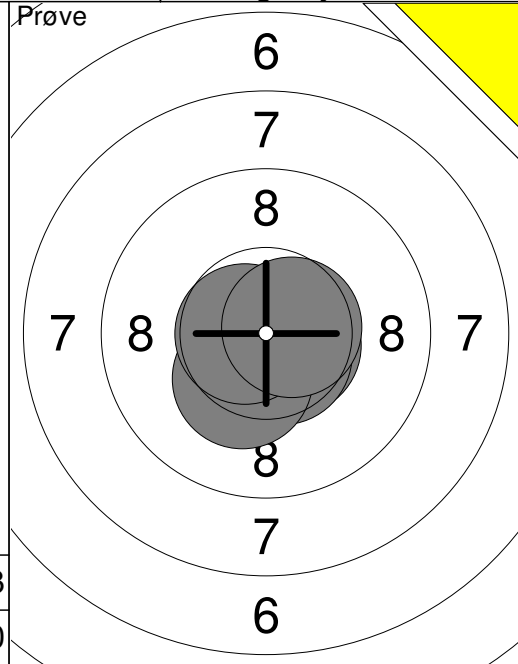

11:	10.6	↘
12:	10.6	↘
13:	10.6	↘
14:	10.3	↘
15:	10.7	↔
16:	10.6	↘
Serie		63.4
Total		0.0

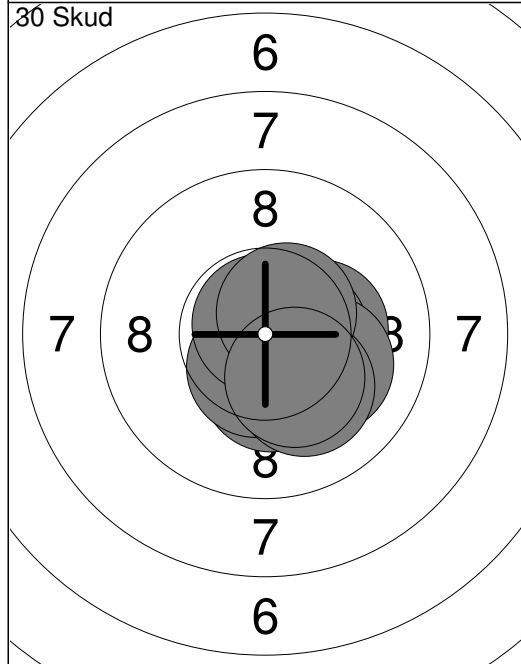

1:	10.3	↘
2:	10.6	↘
3:	10.5	↘
4:	10.3	↘
5:	10.5	↘
6:	10.1	→
7:	10.1	↘
8:	10.8	↗
9:	10.6	↗
10:	10.3	↘
Serie		104.1
Total		104.1

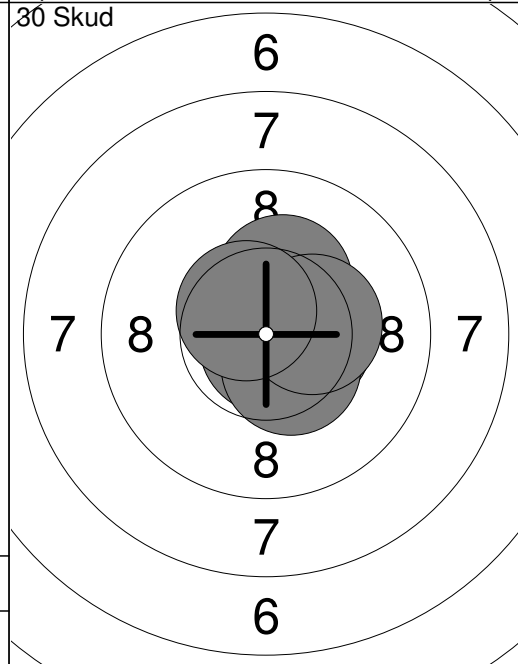

11:	10.8	↘
12:	10.3	↗
13:	10.8	↘
14:	10.5	↘
15:	10.8	↘
16:	10.8	↘
17:	10.8	↘
18:	10.4	↘
19:	10.4	↘
20:	10.6	↘
Serie		106.2
Total		210.3

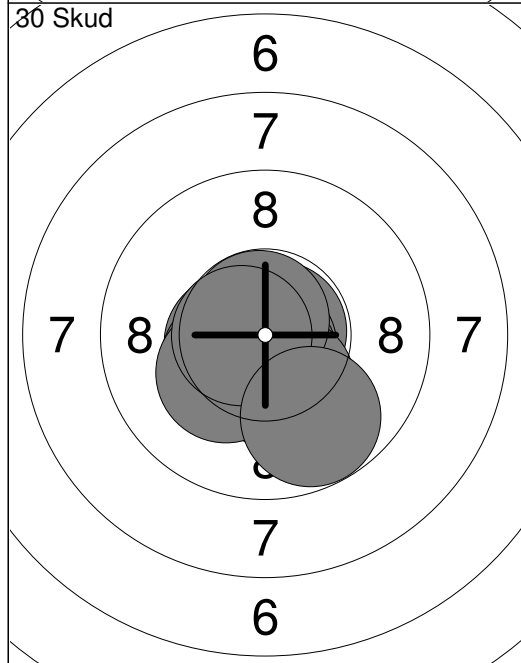

21:	10.8	↘
22:	10.8	↘
23:	10.5	↔
24:	10.4	↔
25:	10.7	↘
26:	10.3	↘
27:	10.7	↗
28:	10.3	↘
29:	10.7	↔
30:	9.8	↘
Serie		105.0
Total		315.3

<p>Prøve</p> <p style="text-align: center; font-size: 24px; font-weight: bold;">8</p>	<p>1: 9.7 ↑</p> <p>2: 9.9 →</p> <p>3: 8.5 ↑</p> <p>4: 10.5x↘</p> <p>5: 9.6 ↑</p> <p>6: 9.2 ↗</p> <p>7: 9.1 →</p> <p>8: 8.5 ↖</p> <p>9: 8.7 ↑</p> <p>10: 9.2 ↗</p>	<p>Prøve</p> <p style="text-align: center; font-size: 24px; font-weight: bold;">8</p>	<p>11: 9.8 ↓</p>
<p style="font-size: 24px; font-weight: bold;">7</p>	<p>Serie 88.0</p> <p>Total 0.0</p>	<p style="font-size: 24px; font-weight: bold;">7</p>	<p>Serie 9.0</p> <p>Total 0.0</p>
<p>40 Skud</p> <p style="text-align: center; font-size: 24px; font-weight: bold;">8</p>	<p>1: 9.5 ↑</p> <p>2: 10.3 ↖</p> <p>3: 10.8x↗</p> <p>4: 9.7 ↓</p> <p>5: 8.8 ↖</p> <p>6: 8.4 ↖</p> <p>7: 9.1 ↘</p> <p>8: 9.9 ←</p> <p>9: 9.4 ↓</p> <p>10: 9.7 ↑</p>	<p style="text-align: center; font-size: 24px; font-weight: bold;">8</p>	<p>11: 9.4 ↓</p> <p>12: 10.2 ↘</p> <p>13: 9.4 ↖</p> <p>14: 10.3 ↓</p> <p>15: 7.7 ↓</p> <p>16: 10.8x↘</p> <p>17: 10.2 ↓</p> <p>18: 9.7 ←</p> <p>19: 9.5 ↘</p> <p>20: 10.8x↓</p>
<p style="font-size: 24px; font-weight: bold;">7</p>	<p>Serie 90.0</p> <p>Total 90.0</p>	<p style="font-size: 24px; font-weight: bold;">7</p>	<p>Serie 93.0</p> <p>Total 183.0</p>
<p>40 Skud</p> <p style="text-align: center; font-size: 24px; font-weight: bold;">7</p>	<p>21: 10.0 ↓</p> <p>22: 6.8 ↓</p> <p>23: 10.2←</p> <p>24: 10.7x↖</p> <p>25: 9.5 ↓</p> <p>26: 10.6x↘</p> <p>27: 10.2→</p> <p>28: 8.8 ↓</p> <p>29: 9.1 ↓</p> <p>30: 9.3 ↗</p>	<p style="text-align: center; font-size: 24px; font-weight: bold;">8</p>	<p>31: 10.2→</p> <p>32: 10.1 ↖</p> <p>33: 10.4x↗</p> <p>34: 9.4 ↓</p> <p>35: 9.3 ↗</p> <p>36: 10.0 ↓</p> <p>37: 9.4 ↑</p> <p>38: 10.0 ↘</p> <p>39: 9.4 ↓</p> <p>40: 9.8 ↓</p>
<p style="font-size: 24px; font-weight: bold;">7</p>	<p>Serie 91.0</p> <p>Total 274.0</p>	<p style="font-size: 24px; font-weight: bold;">7</p>	<p>Serie 95.0</p> <p>Total 369.0</p>

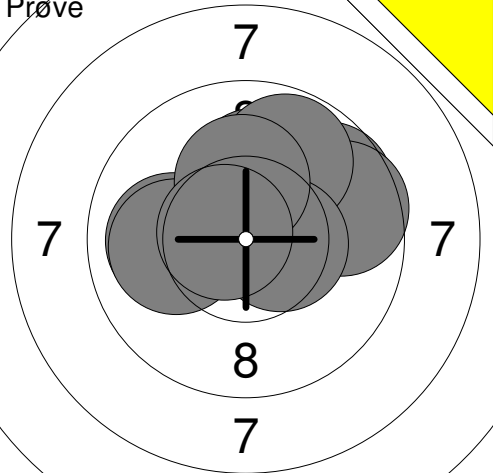
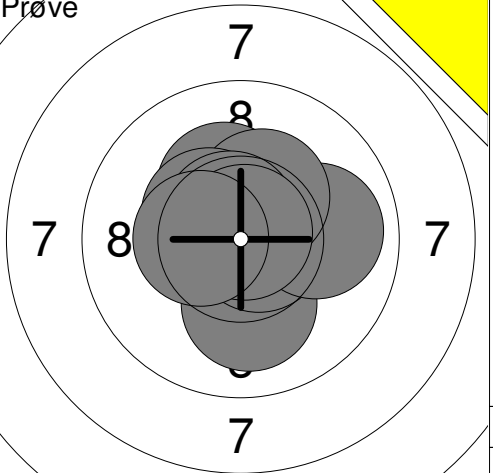
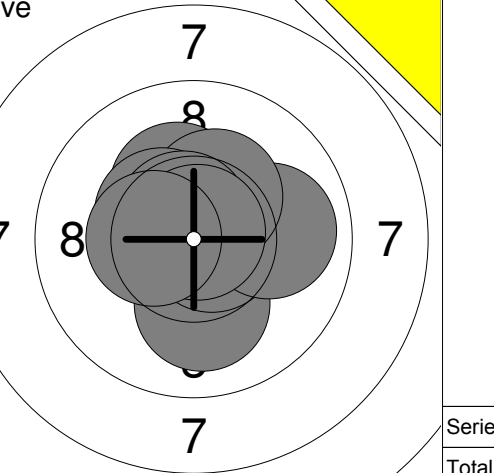
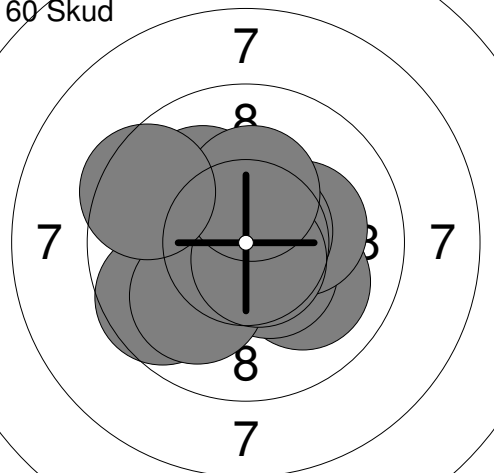
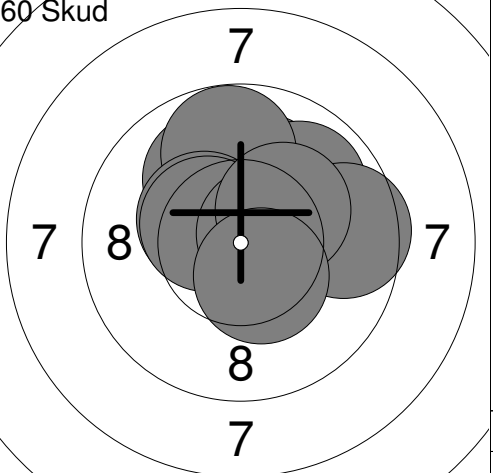
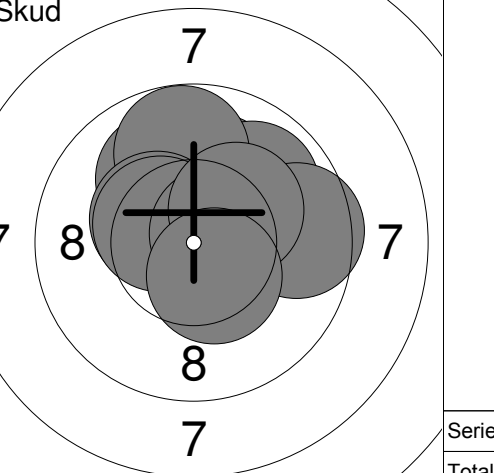
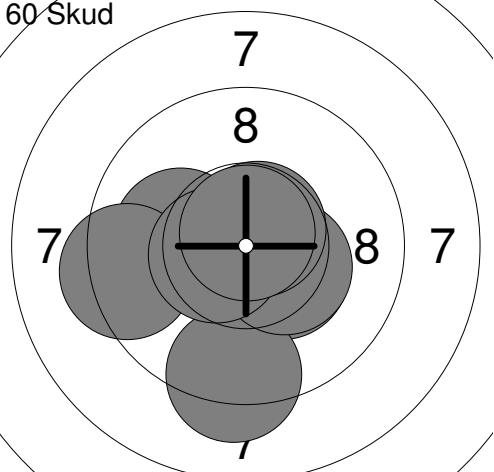
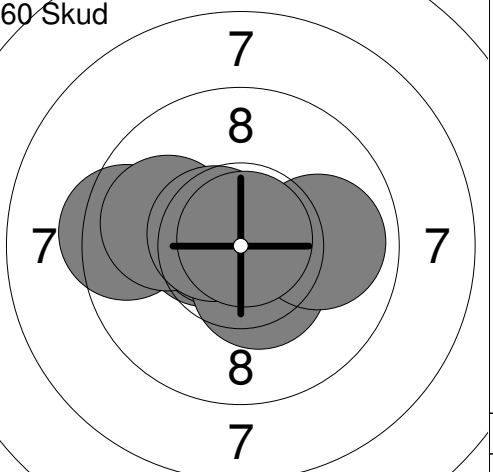
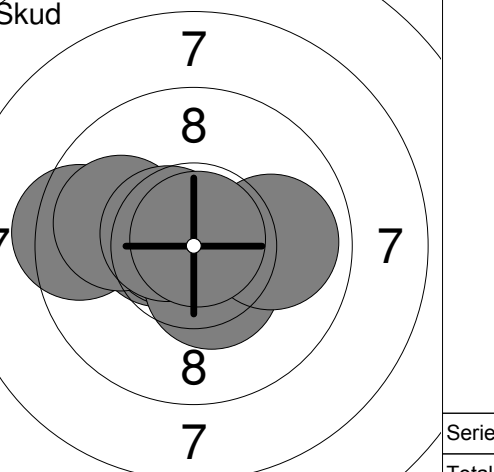
Prøve	Prøve	Prøve
		
1: 9.7 ↗ 2: 10.5x ↗ 3: 10.1 ↑ 4: 9.6 → 5: 9.8 ↗ 6: 10.0 ← 7: 10.0 ← 8: 10.5x → 9: 10.2x ↑ 10: 10.7x ← Serie 101.1 Total 0.0	11: 10.1 ↓ 12: 10.7x → 13: 10.3x ↑ 14: 9.9 → 15: 10.3x ↗ 16: 10.4x ↗ 17: 10.6x ↗ 18: 10.8x ↗ 19: 10.4x ← Serie 93.5 Total 0.0	20: 10.0 ↗ 21: 10.1 ↑ 22: 9.9 ↗ 23: 9.8 ↑ 24: 10.4x ↗ 25: 10.4x ↗ 26: 9.6 → 27: 10.6x → 28: 10.2x ↗ 29: 10.4x ↓ Serie 101.6 Total 101.6
<b>60 Skud</b> 	<b>60 Skud</b> 	<b>60 Skud</b> 
1: 9.6 ← 2: 10.0 ↓ 3: 10.5x ↓ 4: 10.2x → 5: 10.1 ↗ 6: 10.0 ↓ 7: 10.7x ↗ 8: 10.7x ↓ 9: 10.3x ↑ 10: 9.5 ↗ Serie 101.6 Total 101.6	31: 10.7x ↓ 32: 10.9x → 33: 9.4 ← 34: 10.5x ← 35: 10.7x ← 36: 10.4x ↓ 37: 9.9 ← 38: 9.9 → 39: 10.6x ↗ 40: 10.8x ↗ Serie 103.8 Total 409.6	41: 10.1 ← 42: 10.3x ← 43: 10.1 ← 44: 10.4x → 45: 10.6x → 46: 10.2x ← 47: 10.7x ← 48: 9.9 ↓ 49: 10.2x ↓ 50: 10.6x ↓ Serie 103.1 Total 512.7
<b>60 Skud</b> 	<b>60 Skud</b> 	<b>60 Skud</b> 
21: 10.6x → 22: 10.8x ↓ 23: 10.4x ↓ 24: 9.2 ↓ 25: 10.4x ↓ 26: 10.7x ↗ 27: 10.1 ← 28: 9.3 ← 29: 10.5x ← 30: 10.8x ↑ Serie 102.8 Total 305.8	51: 10.0 ↓ 52: 10.2x ← 53: 9.5 → 54: 10.0 ↑ 55: 10.3x ← 56: 10.3x ← 57: 9.9 → 58: 10.6x ↗ 59: 10.7x ↗ 60: 10.3x ↗ Serie 101.8 Total 614.5	41: 10.1 ← 42: 10.3x ← 43: 10.1 ← 44: 10.4x → 45: 10.6x → 46: 10.2x ← 47: 10.7x ← 48: 9.9 ↓ 49: 10.2x ↓ 50: 10.6x ↓ Serie 103.1 Total 512.7

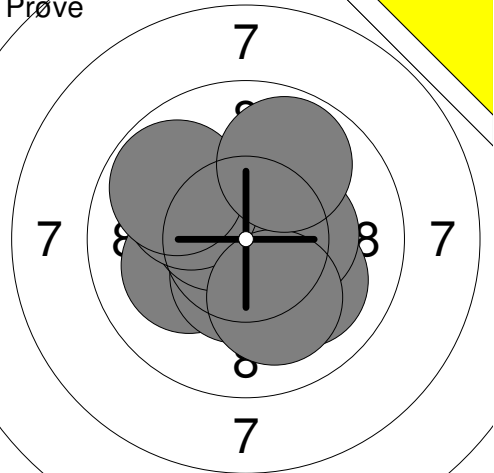
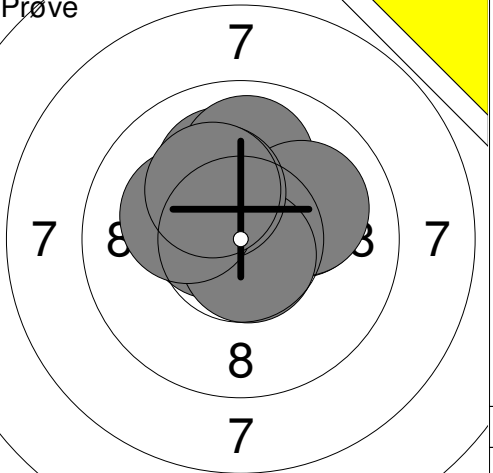
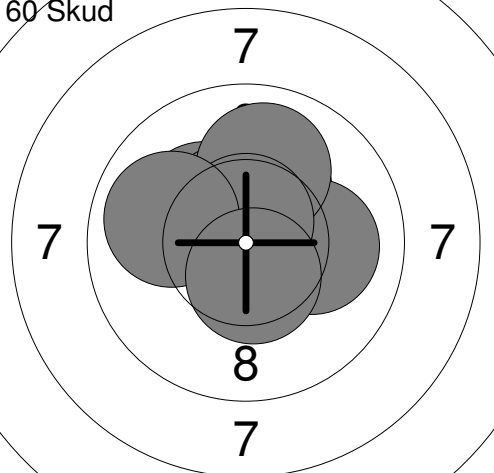
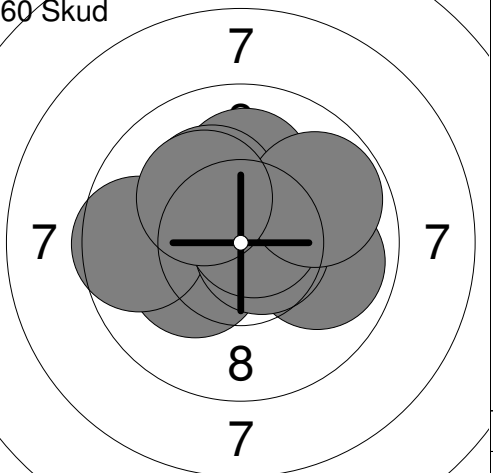
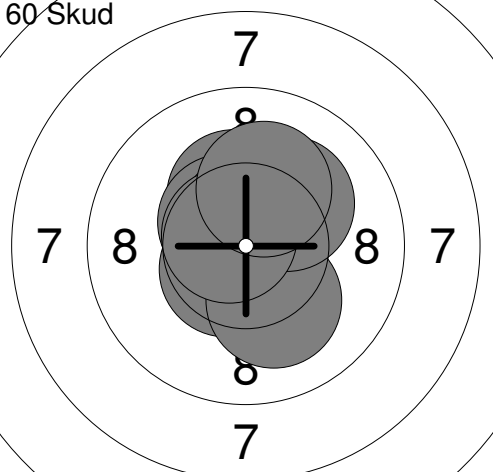
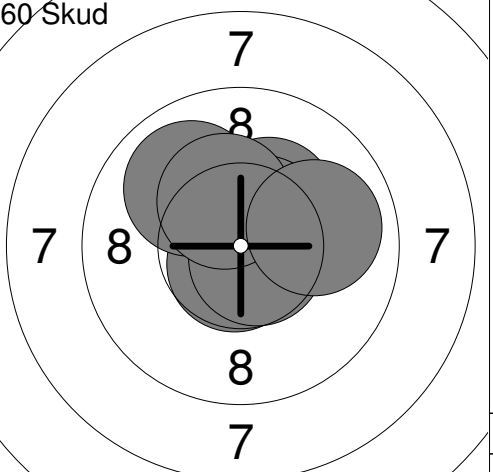
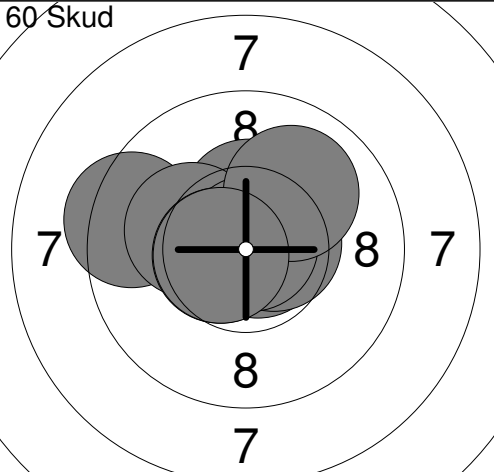
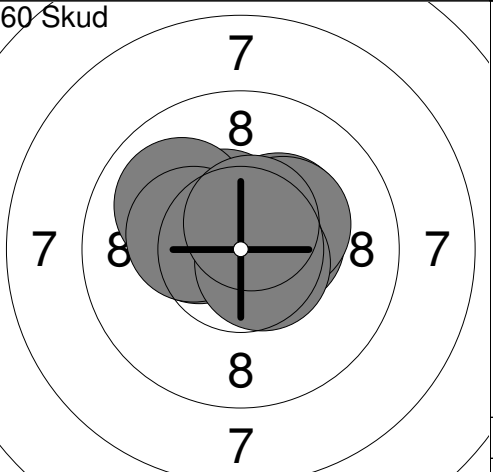

Prøve		Prøve	
	1: 10.1 ↙ 2: 10.5x ↓ 3: 10.1 ↘ 4: 10.5x ↓ 5: 10.5x ↗ 6: 10.3x → 7: 10.1 ↗ 8: 9.8 ↗ 9: 10.1 ↓ 10: 9.8 ↗ Serie 101.8 Total 0.0		11: 10.1 ↗ 12: 10.1 ↗ 13: 10.6x ↖ 14: 10.0 ↑ 15: 10.4x ↗ 16: 10.1 ↗ 17: 10.7x ↓ 18: 10.3x ↗ 19: 10.2x ↖ 20: 10.2x ↗ Serie 102.7 Total 0.0
<b>60 Skud</b> 	1: 10.2x ↗ 2: 10.6x ↗ 3: 10.1 → 4: 10.3x ↗ 5: 10.9x ↖ 6: 10.5x ↗ 7: 10.0 ↑ 8: 10.7x ↗ 9: 9.9 ↖ 10: 10.5x ↓ Serie 103.7 Total 103.7	<b>60 Skud</b> 	11: 10.3x ↖ 12: 10.1 ↑ 13: 10.2x ↗ 14: 9.6 ↖ 15: 10.5x → 16: 9.9 → 17: 10.7x → 18: 10.7x ↗ 19: 9.8 ↗ 20: 10.2x ↗ Serie 102.0 Total 205.7
<b>60 Skud</b> 	21: 10.6x ↗ 22: 10.8x ↓ 23: 10.3x ↗ 24: 10.5x ↗ 25: 10.6x ↗ 26: 10.6x ↘ 27: 10.1 ↓ 28: 10.2x ↗ 29: 10.7x ↖ 30: 10.2x ↗ Serie 104.6 Total 310.3	<b>60 Skud</b> 	31: 10.3x ↗ 32: 10.4x ↗ 33: 10.7x ↓ 34: 10.7x → 35: 10.3x ↗ 36: 10.0 ↖ 37: 10.5x ↗ 38: 10.7x ↘ 39: 10.3x ↗ 40: 10.0 → Serie 103.9 Total 414.2
<b>60 Skud</b> 	41: 10.8x ↖ 42: 10.4x ↗ 43: 9.4 ↖ 44: 10.2x ↖ 45: 10.6x ↖ 46: 10.8x → 47: 10.6x → 48: 10.9x ↗ 49: 10.0 ↗ 50: 10.6x ↖ Serie 104.3 Total 518.5	<b>60 Skud</b> 	51: 10.3x ↗ 52: 10.5x → 53: 10.4x ↖ 54: 10.7x ↗ 55: 10.3x ↗ 56: 10.5x ↗ 57: 10.0 ↖ 58: 10.3x ↖ 59: 10.6x ↘ 60: 10.6x ↗ Serie 104.2 Total 622.7

<p>Prøve</p>	<p>1: 10.1 →</p> <p>2: 9.6 ↘</p> <p>3: 10.2 ✕</p> <p>4: 10.5 ✕</p> <p>5: 10.7 ✕↑</p> <p>6: 10.5 ✕</p> <p>7: 10.4 ✕↓</p> <p>8: 10.5 ✕</p> <p>9: 9.6 →</p> <p>10: 10.3 ✕→</p>	<p>Prøve</p>	<p>11: 10.7 ✕→</p> <p>12: 10.7 ✕↑</p> <p>13: 10.9 ✕↑</p> <p>14: 9.9 →</p> <p>15: 10.1 ↖</p> <p>16: 10.6 ✕↓</p> <p>17: 10.5 ✕↓</p> <p>18: 10.1 →</p> <p>19: 10.4 ✕→</p> <p>20: 10.4 ✕↑</p>
Serie 102.4	Total 0.0	Serie 104.3	Total 0.0

<p>40 Skud</p>	<p>1: 10.6 ✕↑</p> <p>2: 10.3 ✕</p> <p>3: 10.4 ✕↑</p> <p>4: 10.6 ✕</p> <p>5: 10.3 ✕↑</p> <p>6: 10.3 ✕</p> <p>7: 9.7 ↗</p> <p>8: 10.4 ✕↑</p> <p>9: 10.4 ✕→</p> <p>10: 10.1 →</p>	<p>40 Skud</p>	<p>11: 9.4 →</p> <p>12: 10.1 ↓</p> <p>13: 10.2 ✕→</p> <p>14: 10.3 ✕</p> <p>15: 10.1 ↖</p> <p>16: 10.4 ✕→</p> <p>17: 9.8 ←</p> <p>18: 9.9 →</p> <p>19: 10.3 ✕→</p> <p>20: 9.9 ←</p>
Serie 103.1	Total 103.1	Serie 100.4	Total 203.5

<p>40 Skud</p>	<p>21: 10.8 ✕↓</p> <p>22: 10.2 ✕↓</p> <p>23: 10.4 ✕↑</p> <p>24: 10.2 ✕↓</p> <p>25: 10.5 ✕→</p> <p>26: 9.4 ←</p> <p>27: 9.3 ←</p> <p>28: 10.6 ✕</p> <p>29: 10.8 ✕↑</p> <p>30: 9.8 ↖</p>	<p>40 Skud</p>	<p>31: 10.3 ✕→</p> <p>32: 10.6 ✕</p> <p>33: 10.4 ✕</p> <p>34: 10.0 ↑</p> <p>35: 10.0 ←</p> <p>36: 10.5 ✕</p> <p>37: 10.0 →</p> <p>38: 10.4 ✕→</p> <p>39: 10.4 ✕</p> <p>40: 10.0 ←</p>
Serie 102.0	Total 305.5	Serie 102.6	Total 408.1

Prøve 	1: 9.7 ↙ 2: 9.5 → 3: 10.7✕ 4: 10.4✕ 5: 10.3✕↗ 6: 9.8 ↘ 7: 9.7 ↘ 8: 9.6 ↙ 9: 10.2✕↗ 10: 9.8 → Serie 99.7 Total 0.0	Prøve 	11: 10.0 ↙ 12: 9.3 → 13: 10.4✕↗ 14: 10.2✕↗ 15: 10.8✕↘ 16: 10.1 ↙ Serie 60.8 Total 0.0
---	--	---	--

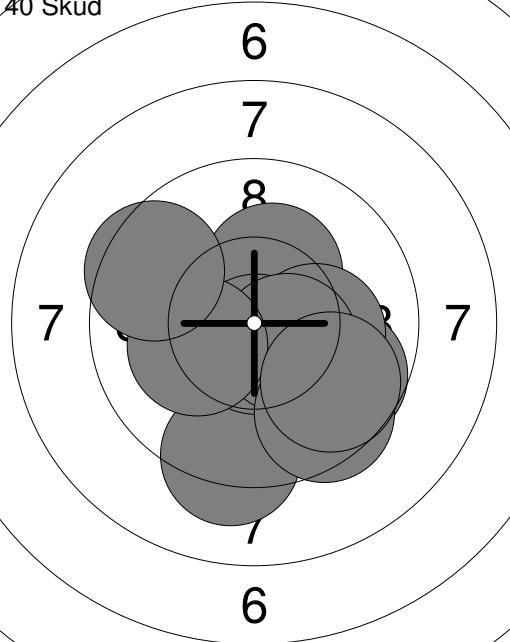
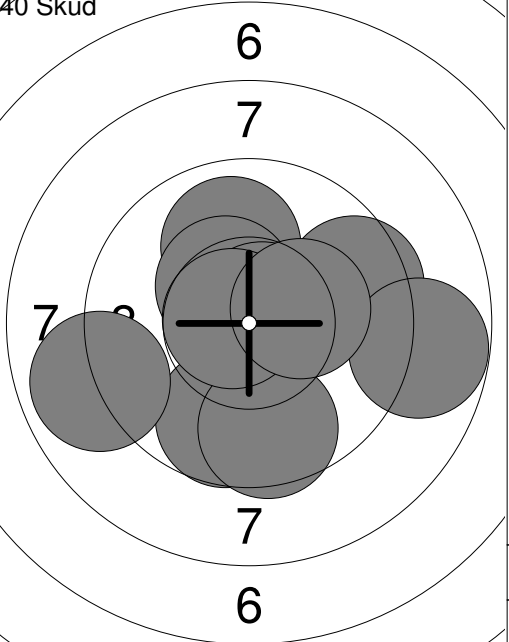
40 Skud 	1: 9.7 → 2: 10.3✕↗ 3: 10.2✕↗ 4: 9.2 ↓ 5: 10.7✕↘ 6: 10.5✕↘ 7: 10.2✕↘ 8: 9.5 ↙ 9: 9.5 ↘ 10: 9.7 ↘ Serie 99.5 Total 99.5	40 Skud 	11: 9.9 ↗ 12: 9.5 → 13: 10.4✕↗ 14: 9.7 ↓ 15: 10.7✕↗ 16: 9.6 ↓ 17: 8.9 ↙ 18: 8.8 → 19: 10.7✕↗ 20: 10.3✕↗ Serie 98.5 Total 198.0
--	--	--	---

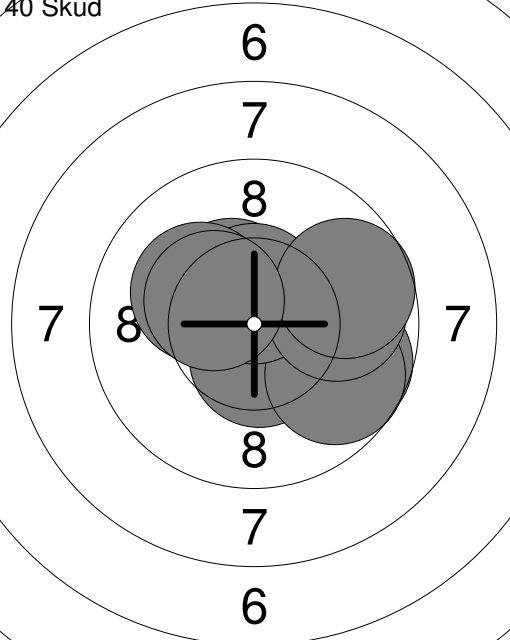
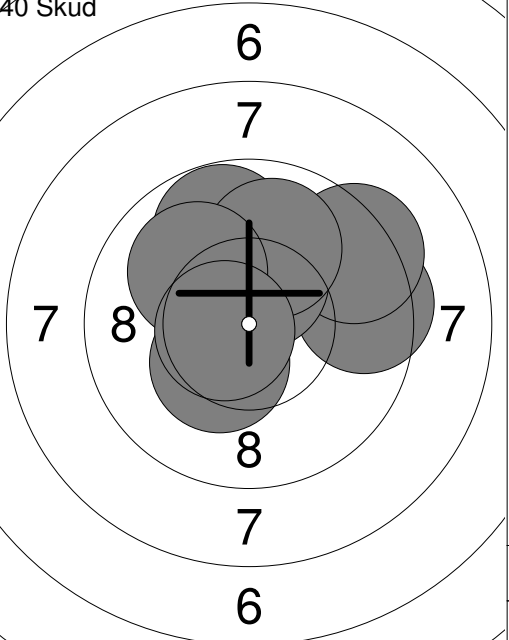
40 Skud 	21: 10.5✕↘ 22: 9.7 → 23: 10.5✕↘ 24: 10.4✕↗ 25: 9.7 ↘ 26: 10.6✕↗ 27: 9.9 → 28: 10.2✕↗ 29: 9.7 → 30: 10.4✕↗ Serie 101.6 Total 299.6	40 Skud 	31: 9.5 → 32: 9.3 → 33: 10.5✕↗ 34: 9.8 ↗ 35: 10.5✕↗ 36: 10.4✕↗ 37: 9.9 ↗ 38: 10.3✕↗ 39: 10.0 ↙ 40: 10.6✕↗ Serie 100.8 Total 400.4
---	--	---	--

	10 meter luftstævne 2015	Aalborg Skyttekreds
--	--------------------------	---------------------

Prøve	10 meter luftstævne 2015	Prøve	Aalborg Skyttekreds
	1: 4.7 2: 10.3x 3: 9.1 4: 7.1 5: 9.4 6: 8.4 7: 9.7 8: 9.6 9: 9.8 10: 8.2		11: 10.1 12: 10.2x 13: 10.0 14: 10.8x 15: 10.0 16: 10.8x 17: 10.8x 18: 10.7x 19: 10.4x 20: 10.2x
	Serie 86.3		Serie 104.0
	Total 0.0		Total 0.0

Prøve	10 meter luftstævne 2015	60 Skud	Aalborg Skyttekreds
	21: 9.4 22: 9.8 23: 10.9x 24: 9.5		1: 9.2 2: 10.0 3: 9.3 4: 10.3x 5: 9.1 6: 10.2x 7: 8.7 8: 9.5 9: 10.5x 10: 8.1
	Serie 39.6		Serie 94.9
	Total 0.0		Total 94.9

60 Skud	10 meter luftstævne 2015	60 Skud	Aalborg Skyttekreds
	11: 10.2x 12: 10.0 13: 10.1 14: 10.4x 15: 10.0 16: 9.9 17: 10.1 18: 9.9 19: 10.5x 20: 10.4x		21: 10.2x 22: 9.8 23: 9.9 24: 9.6 25: 10.4x 26: 9.4 27: 10.1 28: 10.8x 29: 10.0 30: 9.9
	Serie 101.5		Serie 100.1
	Total 196.4		Total 296.5

60 Skud	10 meter luftstævne 2015	60 Skud	Aalborg Skyttekreds
	31: 10.5x 32: 10.4x 33: 10.7x 34: 10.2x 35: 9.5 36: 10.1 37: 10.0 38: 9.8 39: 10.6x 40: 9.6		41: 10.9x 42: 9.7 43: 10.1 44: 10.5x 45: 10.8x 46: 9.2 47: 10.5x 48: 9.5 49: 10.0 50: 10.5x
	Serie 101.4		Serie 101.7
	Total 397.9		Total 499.6

60 Skud	10 meter luftstævne 2015		
	51: 9.6 52: 10.5x 53: 10.2x 54: 9.7 55: 9.9 56: 10.4x 57: 9.5 58: 9.7 59: 10.0 60: 10.8x		
	Serie 100.3		
	Total 599.9		

	10 meter luftstævne 2015	Aalborg Skyttekreds
--	--------------------------	---------------------

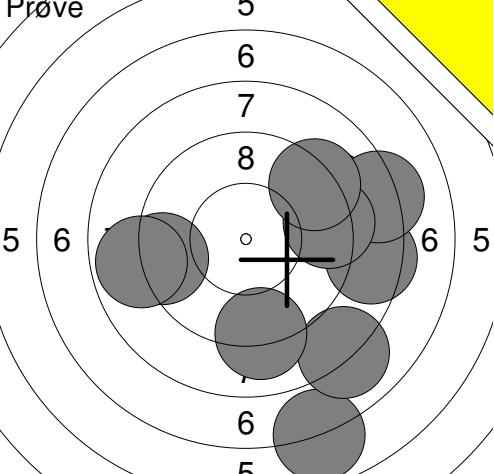
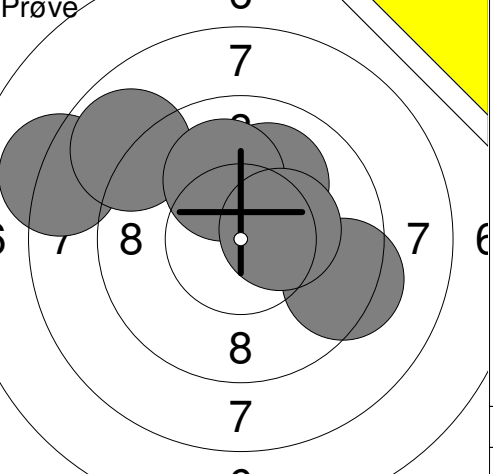
<p>Prøve</p> 	<p>1: 6.9 ↓ 2: 8.0 ↓ 3: 9.1 ↓ 4: 9.3 ← 5: 8.5 → 6: 9.1 → 7: 8.2 → 8: 9.3 → 9: 9.2 ↗ 10: 8.9 ←</p> <p>Serie 86.5 Total 0.0</p>	<p>Prøve</p> 	<p>11: 8.2 ↖ 12: 8.9 ↗ 13: 10.0 ↗ 14: 10.0 ↗ 15: 9.3 → 16: 10.4x →</p> <p>Serie 56.8 Total 0.0</p>
---	---	---	--

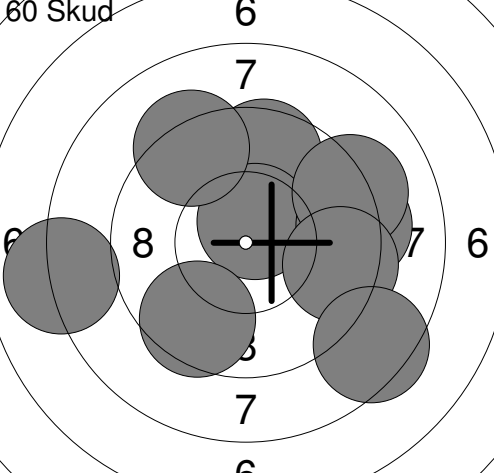
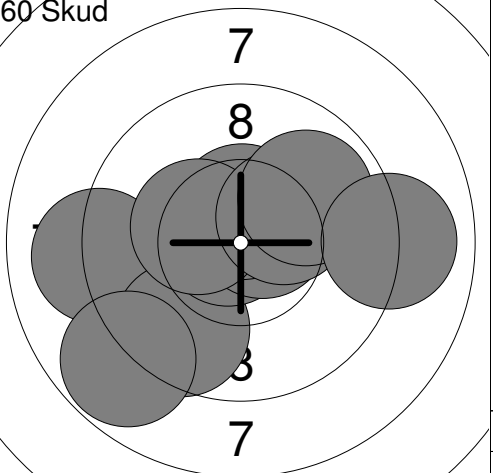
<p>60 Skud</p> 	<p>1: 9.6 ↑ 2: 9.5 → 3: 10.6x ↑ 4: 9.3 ↗ 5: 9.3 → 6: 8.0 ← 7: 9.1 → 8: 9.5 ↓ 9: 9.4 → 10: 8.4 ↓</p> <p>Serie 92.7 Total 92.7</p>	<p>60 Skud</p> 	<p>11: 9.1 ← 12: 9.6 ↓ 13: 10.8x ← 14: 10.6x ↗ 15: 10.5x ↑ 16: 8.8 ↓ 17: 10.4x ← 18: 10.3x ↗ 19: 9.9 ↗ 20: 9.0 →</p> <p>Serie 99.0 Total 191.7</p>
--	--	--	--

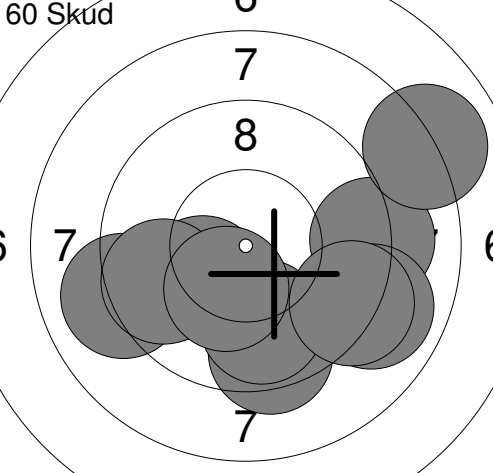
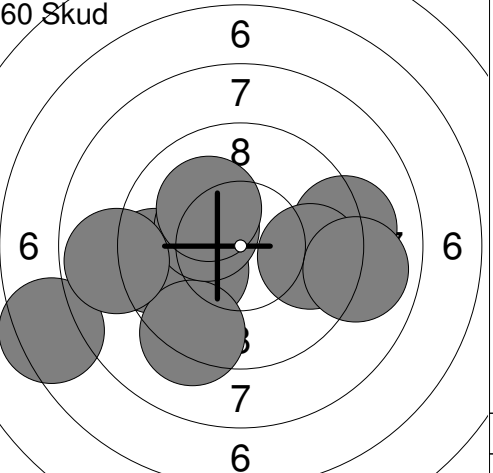
<p>60 Skud</p> 	<p>21: 9.4 ↓ 22: 9.0 ← 23: 9.1 → 24: 10.2x ← 25: 9.8 ↓ 26: 8.9 → 27: 9.2 ↓ 28: 9.7 ← 29: 8.0 → 30: 10.3x ↓</p> <p>Serie 93.6 Total 285.3</p>	<p>60 Skud</p> 	<p>31: 10.1 ↖ 32: 7.4 ← 33: 9.5 ← 34: 9.3 ↓ 35: 9.2 → 36: 10.3x ↖ 37: 8.8 ← 38: 9.8 → 39: 10.1 ↗ 40: 9.0 →</p> <p>Serie 93.5 Total 378.8</p>
---	--	---	--

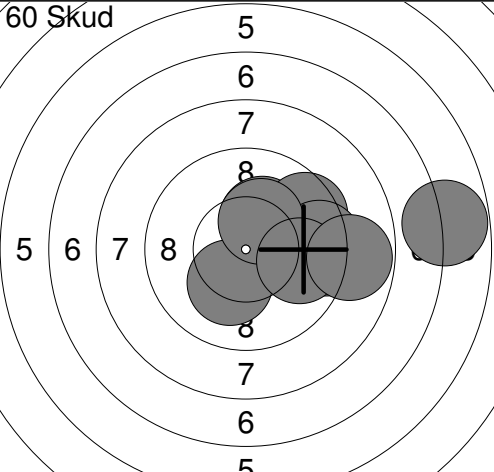
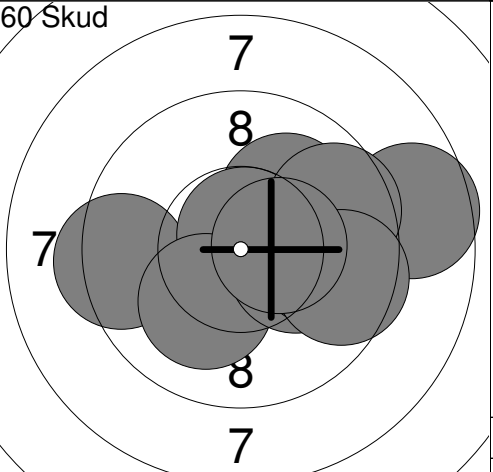
<p>60 Skud</p> 	<p>41: 9.8 → 42: 6.8 → 43: 10.2x ↓ 44: 9.3 → 45: 10.2x ↗ 46: 9.5 ↗ 47: 9.4 → 48: 10.3x ↗ 49: 9.8 → 50: 8.8 →</p> <p>Serie 94.1 Total 472.9</p>	<p>60 Skud</p> 	<p>51: 10.1 ↗ 52: 9.4 ← 53: 10.8x ↗ 54: 8.6 → 55: 10.1 ↓ 56: 10.2x → 57: 9.9 → 58: 9.6 ↗ 59: 9.6 → 60: 10.4x →</p> <p>Serie 98.7 Total 571.6</p>
---	--	---	--

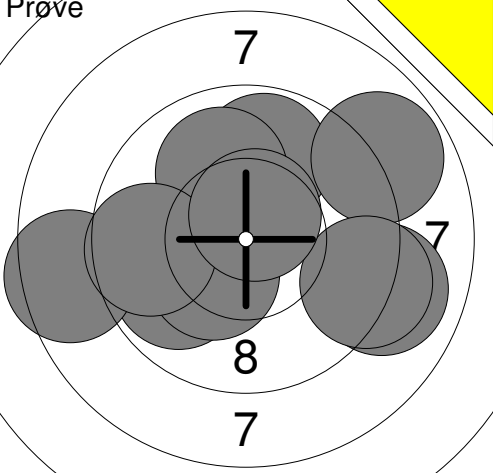
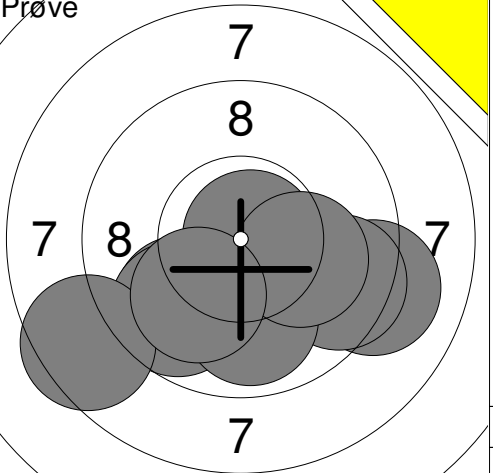
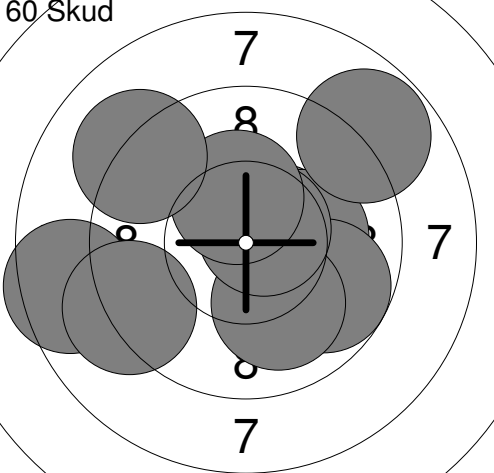
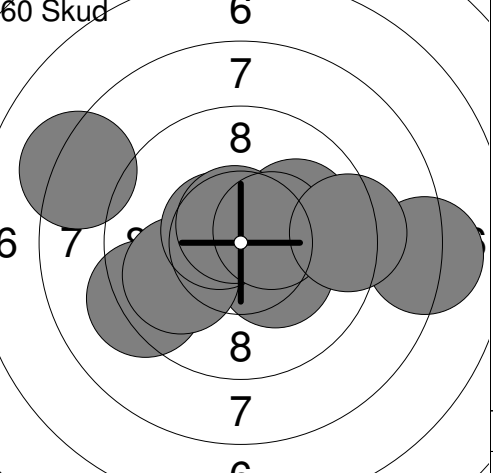
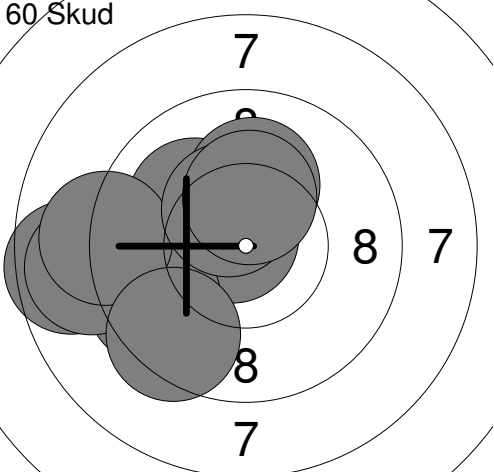
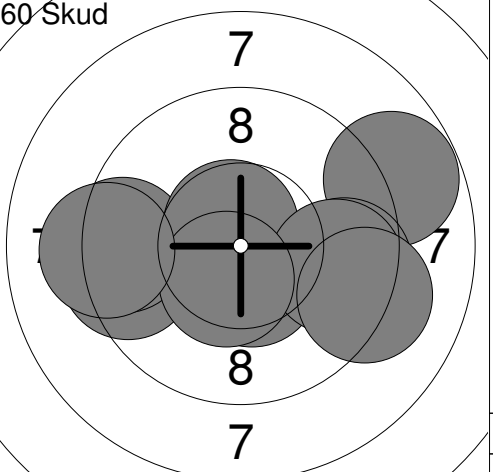
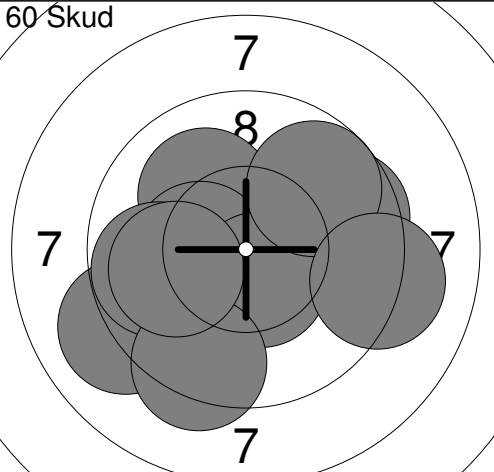
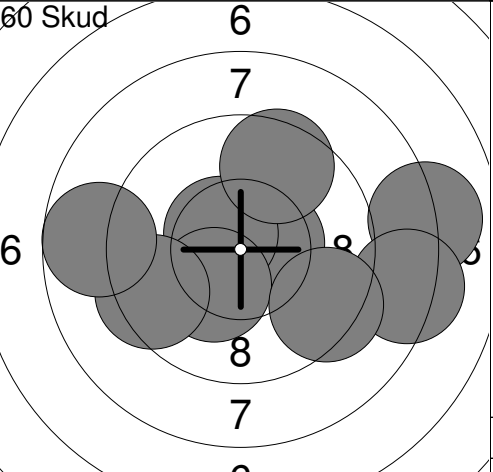
<b>Prøve</b> 	<table border="1" style="width:100%; border-collapse: collapse;"> <tr><td>1: 9.9</td><td>↙</td></tr> <tr><td>2: 9.8</td><td>↑</td></tr> <tr><td>3: 8.5</td><td>←</td></tr> <tr><td>4: 10.0</td><td>↑</td></tr> <tr><td>5: 8.9</td><td>↗</td></tr> <tr><td>6: 10.3x</td><td>↙</td></tr> <tr><td>7: 9.0</td><td>→</td></tr> <tr><td>8: 9.6</td><td>←</td></tr> <tr><td>9: 9.2</td><td>→</td></tr> <tr><td>10: 10.6x</td><td>↑</td></tr> <tr><td><b>Serie</b></td><td><b>95.8</b></td></tr> <tr><td><b>Total</b></td><td><b>0.0</b></td></tr> </table>	1: 9.9	↙	2: 9.8	↑	3: 8.5	←	4: 10.0	↑	5: 8.9	↗	6: 10.3x	↙	7: 9.0	→	8: 9.6	←	9: 9.2	→	10: 10.6x	↑	<b>Serie</b>	<b>95.8</b>	<b>Total</b>	<b>0.0</b>	<b>Prøve</b> 	<table border="1" style="width:100%; border-collapse: collapse;"> <tr><td>11: 9.8</td><td>↙</td></tr> <tr><td>12: 10.8x</td><td>→</td></tr> <tr><td>13: 9.7</td><td>↙</td></tr> <tr><td>14: 9.1</td><td>→</td></tr> <tr><td>15: 9.5</td><td>→</td></tr> <tr><td>16: 9.9</td><td>↘</td></tr> <tr><td>17: 10.1</td><td>→</td></tr> <tr><td>18: 8.5</td><td>↙</td></tr> <tr><td>19: 10.0</td><td>↙</td></tr> <tr><td><b>Serie</b></td><td><b>87.4</b></td></tr> <tr><td><b>Total</b></td><td><b>0.0</b></td></tr> </table>	11: 9.8	↙	12: 10.8x	→	13: 9.7	↙	14: 9.1	→	15: 9.5	→	16: 9.9	↘	17: 10.1	→	18: 8.5	↙	19: 10.0	↙	<b>Serie</b>	<b>87.4</b>	<b>Total</b>	<b>0.0</b>		
1: 9.9	↙																																																		
2: 9.8	↑																																																		
3: 8.5	←																																																		
4: 10.0	↑																																																		
5: 8.9	↗																																																		
6: 10.3x	↙																																																		
7: 9.0	→																																																		
8: 9.6	←																																																		
9: 9.2	→																																																		
10: 10.6x	↑																																																		
<b>Serie</b>	<b>95.8</b>																																																		
<b>Total</b>	<b>0.0</b>																																																		
11: 9.8	↙																																																		
12: 10.8x	→																																																		
13: 9.7	↙																																																		
14: 9.1	→																																																		
15: 9.5	→																																																		
16: 9.9	↘																																																		
17: 10.1	→																																																		
18: 8.5	↙																																																		
19: 10.0	↙																																																		
<b>Serie</b>	<b>87.4</b>																																																		
<b>Total</b>	<b>0.0</b>																																																		
<b>60 Skud</b> 	<table border="1" style="width:100%; border-collapse: collapse;"> <tr><td>1: 8.5</td><td>←</td></tr> <tr><td>2: 10.5x</td><td>→</td></tr> <tr><td>3: 10.2x</td><td>→</td></tr> <tr><td>4: 9.8</td><td>↘</td></tr> <tr><td>5: 10.0</td><td>↘</td></tr> <tr><td>6: 9.2</td><td>←</td></tr> <tr><td>7: 10.6x</td><td>↗</td></tr> <tr><td>8: 10.3x</td><td>↑</td></tr> <tr><td>9: 9.1</td><td>↗</td></tr> <tr><td>10: 8.8</td><td>↗</td></tr> <tr><td><b>Serie</b></td><td><b>97.0</b></td></tr> <tr><td><b>Total</b></td><td><b>97.0</b></td></tr> </table>	1: 8.5	←	2: 10.5x	→	3: 10.2x	→	4: 9.8	↘	5: 10.0	↘	6: 9.2	←	7: 10.6x	↗	8: 10.3x	↑	9: 9.1	↗	10: 8.8	↗	<b>Serie</b>	<b>97.0</b>	<b>Total</b>	<b>97.0</b>	<b>60 Skud</b> 	<table border="1" style="width:100%; border-collapse: collapse;"> <tr><td>11: 10.0</td><td>→</td></tr> <tr><td>12: 9.3</td><td>←</td></tr> <tr><td>13: 8.1</td><td>→</td></tr> <tr><td>14: 8.2</td><td>←</td></tr> <tr><td>15: 10.3x</td><td>↘</td></tr> <tr><td>16: 9.9</td><td>←</td></tr> <tr><td>17: 10.6x</td><td>←</td></tr> <tr><td>18: 10.7x</td><td>↑</td></tr> <tr><td>19: 10.4x</td><td>→</td></tr> <tr><td>20: 9.3</td><td>→</td></tr> <tr><td><b>Serie</b></td><td><b>96.8</b></td></tr> <tr><td><b>Total</b></td><td><b>193.8</b></td></tr> </table>	11: 10.0	→	12: 9.3	←	13: 8.1	→	14: 8.2	←	15: 10.3x	↘	16: 9.9	←	17: 10.6x	←	18: 10.7x	↑	19: 10.4x	→	20: 9.3	→	<b>Serie</b>	<b>96.8</b>	<b>Total</b>	<b>193.8</b>
1: 8.5	←																																																		
2: 10.5x	→																																																		
3: 10.2x	→																																																		
4: 9.8	↘																																																		
5: 10.0	↘																																																		
6: 9.2	←																																																		
7: 10.6x	↗																																																		
8: 10.3x	↑																																																		
9: 9.1	↗																																																		
10: 8.8	↗																																																		
<b>Serie</b>	<b>97.0</b>																																																		
<b>Total</b>	<b>97.0</b>																																																		
11: 10.0	→																																																		
12: 9.3	←																																																		
13: 8.1	→																																																		
14: 8.2	←																																																		
15: 10.3x	↘																																																		
16: 9.9	←																																																		
17: 10.6x	←																																																		
18: 10.7x	↑																																																		
19: 10.4x	→																																																		
20: 9.3	→																																																		
<b>Serie</b>	<b>96.8</b>																																																		
<b>Total</b>	<b>193.8</b>																																																		
<b>60 Skud</b> 	<table border="1" style="width:100%; border-collapse: collapse;"> <tr><td>21: 8.6</td><td>←</td></tr> <tr><td>22: 10.1</td><td>↗</td></tr> <tr><td>23: 10.7x</td><td>↗</td></tr> <tr><td>24: 10.1</td><td>↑</td></tr> <tr><td>25: 9.5</td><td>←</td></tr> <tr><td>26: 8.9</td><td>←</td></tr> <tr><td>27: 9.1</td><td>←</td></tr> <tr><td>28: 10.4x</td><td>↗</td></tr> <tr><td>29: 9.4</td><td>↙</td></tr> <tr><td>30: 10.3x</td><td>↑</td></tr> <tr><td><b>Serie</b></td><td><b>97.1</b></td></tr> <tr><td><b>Total</b></td><td><b>290.9</b></td></tr> </table>	21: 8.6	←	22: 10.1	↗	23: 10.7x	↗	24: 10.1	↑	25: 9.5	←	26: 8.9	←	27: 9.1	←	28: 10.4x	↗	29: 9.4	↙	30: 10.3x	↑	<b>Serie</b>	<b>97.1</b>	<b>Total</b>	<b>290.9</b>	<b>60 Skud</b> 	<table border="1" style="width:100%; border-collapse: collapse;"> <tr><td>31: 9.4</td><td>←</td></tr> <tr><td>32: 9.4</td><td>←</td></tr> <tr><td>33: 8.8</td><td>→</td></tr> <tr><td>34: 9.6</td><td>→</td></tr> <tr><td>35: 10.5x</td><td>↘</td></tr> <tr><td>36: 10.7x</td><td>↗</td></tr> <tr><td>37: 9.7</td><td>→</td></tr> <tr><td>38: 9.2</td><td>↘</td></tr> <tr><td>39: 10.5x</td><td>↘</td></tr> <tr><td>40: 9.2</td><td>←</td></tr> <tr><td><b>Serie</b></td><td><b>97.0</b></td></tr> <tr><td><b>Total</b></td><td><b>387.9</b></td></tr> </table>	31: 9.4	←	32: 9.4	←	33: 8.8	→	34: 9.6	→	35: 10.5x	↘	36: 10.7x	↗	37: 9.7	→	38: 9.2	↘	39: 10.5x	↘	40: 9.2	←	<b>Serie</b>	<b>97.0</b>	<b>Total</b>	<b>387.9</b>
21: 8.6	←																																																		
22: 10.1	↗																																																		
23: 10.7x	↗																																																		
24: 10.1	↑																																																		
25: 9.5	←																																																		
26: 8.9	←																																																		
27: 9.1	←																																																		
28: 10.4x	↗																																																		
29: 9.4	↙																																																		
30: 10.3x	↑																																																		
<b>Serie</b>	<b>97.1</b>																																																		
<b>Total</b>	<b>290.9</b>																																																		
31: 9.4	←																																																		
32: 9.4	←																																																		
33: 8.8	→																																																		
34: 9.6	→																																																		
35: 10.5x	↘																																																		
36: 10.7x	↗																																																		
37: 9.7	→																																																		
38: 9.2	↘																																																		
39: 10.5x	↘																																																		
40: 9.2	←																																																		
<b>Serie</b>	<b>97.0</b>																																																		
<b>Total</b>	<b>387.9</b>																																																		
<b>60 Skud</b> 	<table border="1" style="width:100%; border-collapse: collapse;"> <tr><td>41: 9.6</td><td>→</td></tr> <tr><td>42: 10.1</td><td>↗</td></tr> <tr><td>43: 9.1</td><td>←</td></tr> <tr><td>44: 10.4x</td><td>←</td></tr> <tr><td>45: 10.5x</td><td>↘</td></tr> <tr><td>46: 9.8</td><td>←</td></tr> <tr><td>47: 9.3</td><td>↘</td></tr> <tr><td>48: 9.7</td><td>↗</td></tr> <tr><td>49: 10.0</td><td>←</td></tr> <tr><td>50: 9.2</td><td>→</td></tr> <tr><td><b>Serie</b></td><td><b>97.7</b></td></tr> <tr><td><b>Total</b></td><td><b>485.6</b></td></tr> </table>	41: 9.6	→	42: 10.1	↗	43: 9.1	←	44: 10.4x	←	45: 10.5x	↘	46: 9.8	←	47: 9.3	↘	48: 9.7	↗	49: 10.0	←	50: 9.2	→	<b>Serie</b>	<b>97.7</b>	<b>Total</b>	<b>485.6</b>	<b>60 Skud</b> 	<table border="1" style="width:100%; border-collapse: collapse;"> <tr><td>51: 10.6x</td><td>↑</td></tr> <tr><td>52: 10.5x</td><td>→</td></tr> <tr><td>53: 10.5x</td><td>↗</td></tr> <tr><td>54: 8.0</td><td>→</td></tr> <tr><td>55: 10.3x</td><td>↘</td></tr> <tr><td>56: 8.3</td><td>→</td></tr> <tr><td>57: 9.4</td><td>↘</td></tr> <tr><td>58: 9.4</td><td>←</td></tr> <tr><td>59: 8.7</td><td>←</td></tr> <tr><td>60: 9.5</td><td>↑</td></tr> <tr><td><b>Serie</b></td><td><b>95.2</b></td></tr> <tr><td><b>Total</b></td><td><b>580.8</b></td></tr> </table>	51: 10.6x	↑	52: 10.5x	→	53: 10.5x	↗	54: 8.0	→	55: 10.3x	↘	56: 8.3	→	57: 9.4	↘	58: 9.4	←	59: 8.7	←	60: 9.5	↑	<b>Serie</b>	<b>95.2</b>	<b>Total</b>	<b>580.8</b>
41: 9.6	→																																																		
42: 10.1	↗																																																		
43: 9.1	←																																																		
44: 10.4x	←																																																		
45: 10.5x	↘																																																		
46: 9.8	←																																																		
47: 9.3	↘																																																		
48: 9.7	↗																																																		
49: 10.0	←																																																		
50: 9.2	→																																																		
<b>Serie</b>	<b>97.7</b>																																																		
<b>Total</b>	<b>485.6</b>																																																		
51: 10.6x	↑																																																		
52: 10.5x	→																																																		
53: 10.5x	↗																																																		
54: 8.0	→																																																		
55: 10.3x	↘																																																		
56: 8.3	→																																																		
57: 9.4	↘																																																		
58: 9.4	←																																																		
59: 8.7	←																																																		
60: 9.5	↑																																																		
<b>Serie</b>	<b>95.2</b>																																																		
<b>Total</b>	<b>580.8</b>																																																		